

# L96A1 rubber band gun

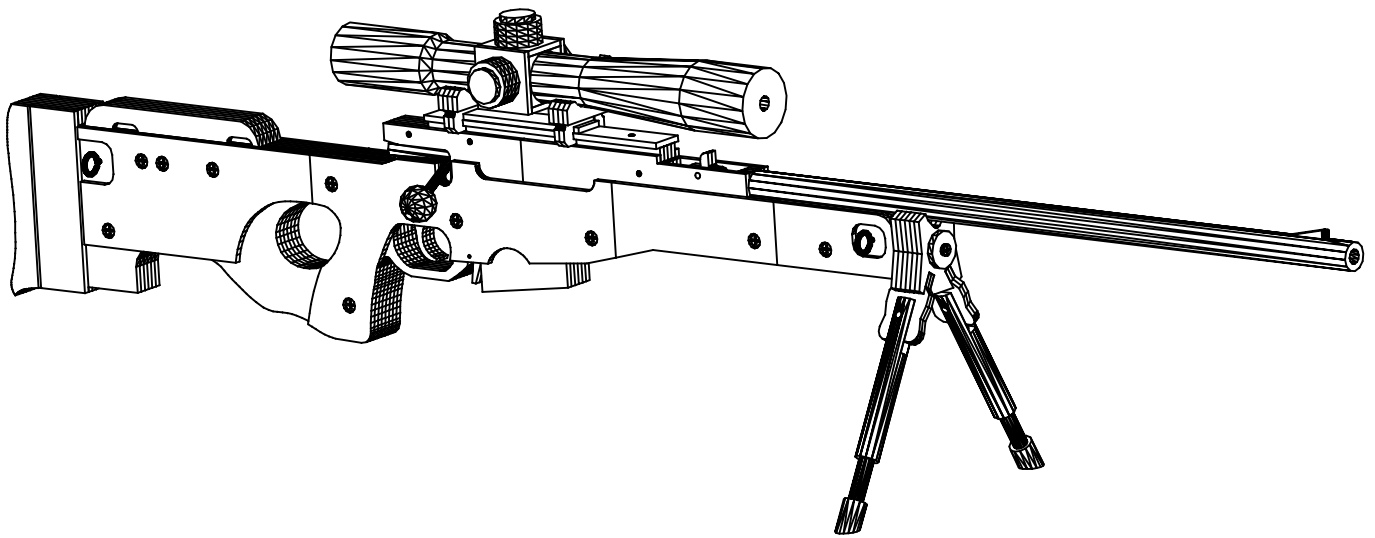

## IMPORTANT!

This is a construction manual for making an harmless rubber band gun. You will make and use it on your own risk. If you don't agree, don't make this rubber band gun.

Please pay attention to laws concerning realistic imitation firearms in your country.

# Materials:

- 4mm plywood ca. 1700x900mm
- 1x ø2mm nail (steel)
- ø20mm hardwood dowel 508mm
- ø16mm hardwood dowel ca. 300mm
- ø6mm hardwood dowel ca. 100mm
- ø4mm hardwood dowel ca. 140mm
- wooden ball ø25mm, ø6mm drilled hole
- 3x screw 3x20mm (countersunk)
- 3x screw 3,5x16mm (countersunk)
- 2x screw 4x55mm (countersunk)
- 10x screw 4x16mm (pan head)
- 2x screw eyes ca. ø14mm
- 1x spring ø4mm
- rubber bands ø40mm (US size #16)
- rubber bands ø100mm (US size #116)

# Tools:

- scroll saw (fret saw)
- drill press (cordless drill)
- sandpaper
- wood glue
- clamps
- screwdriver
- ø2, ø3, ø4, ø6, ø10mm brad point drill

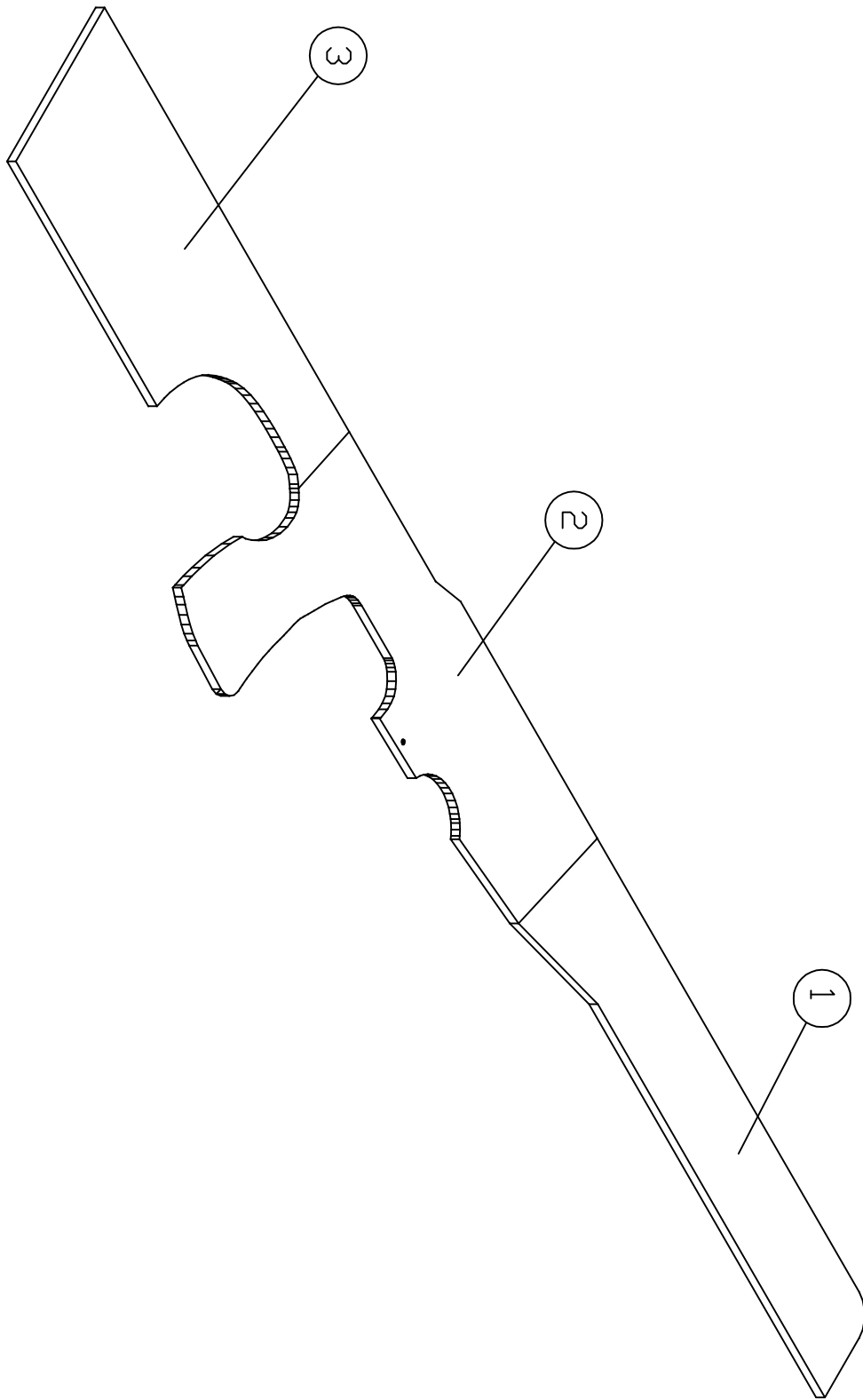

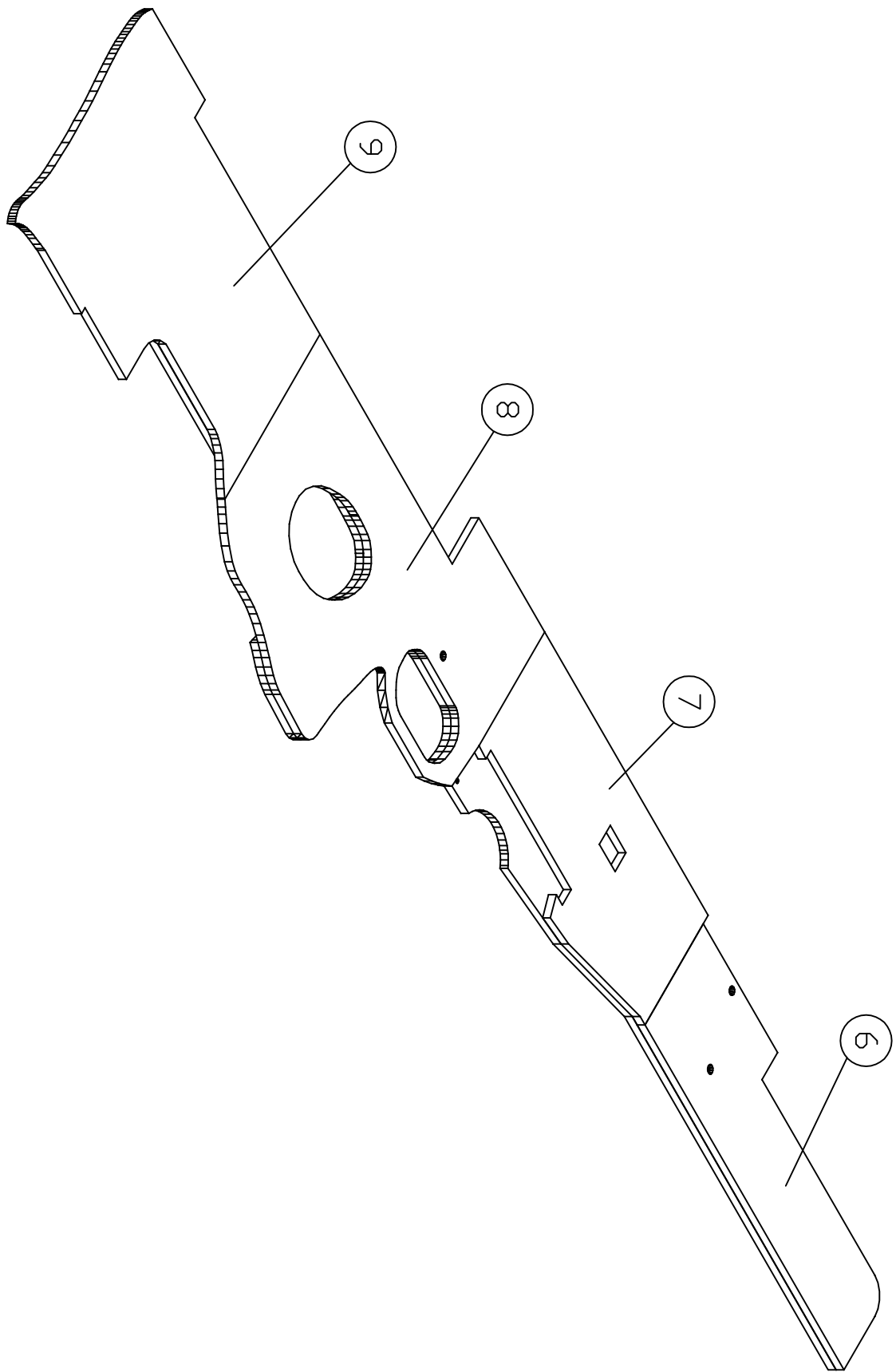

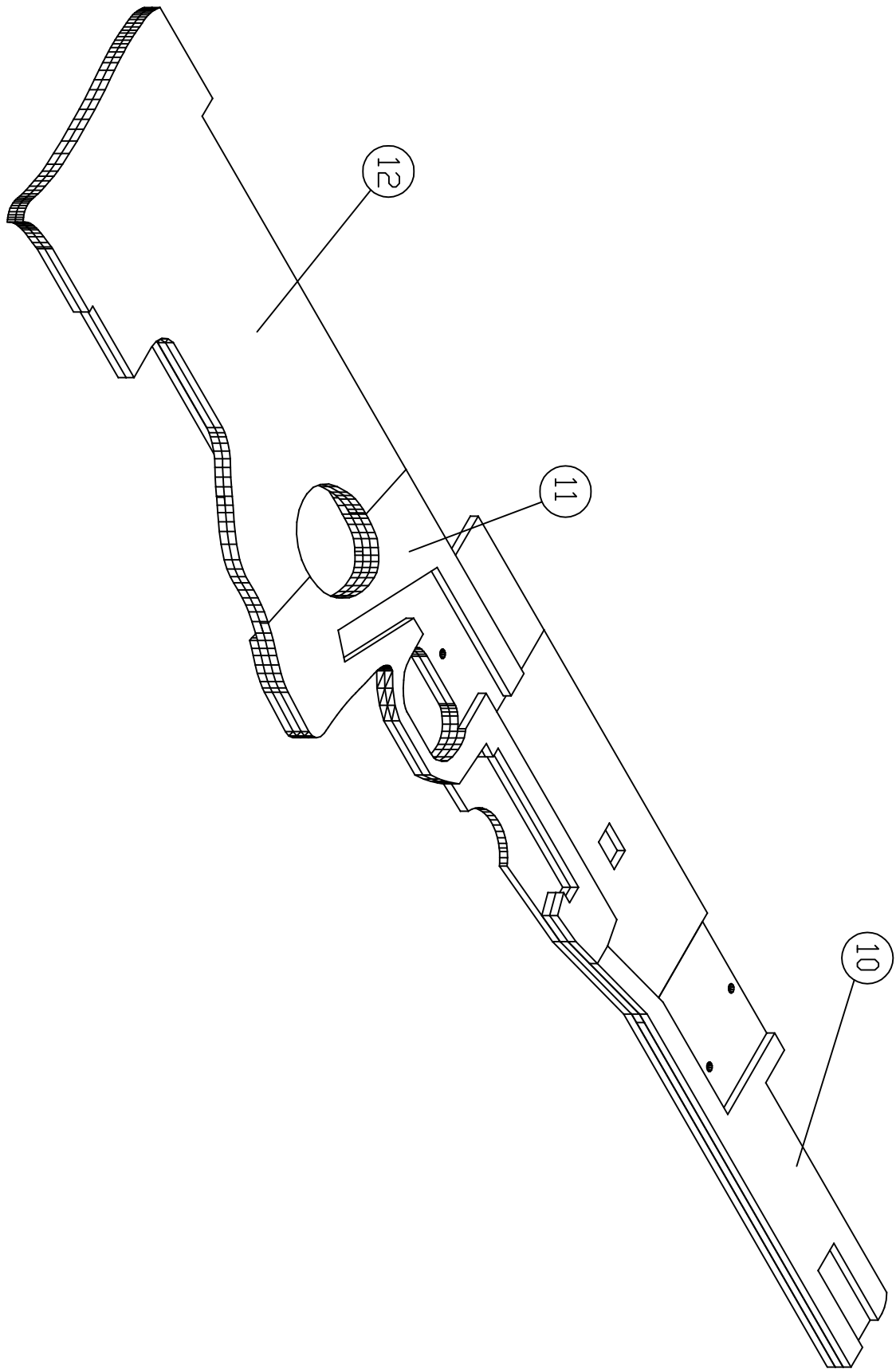

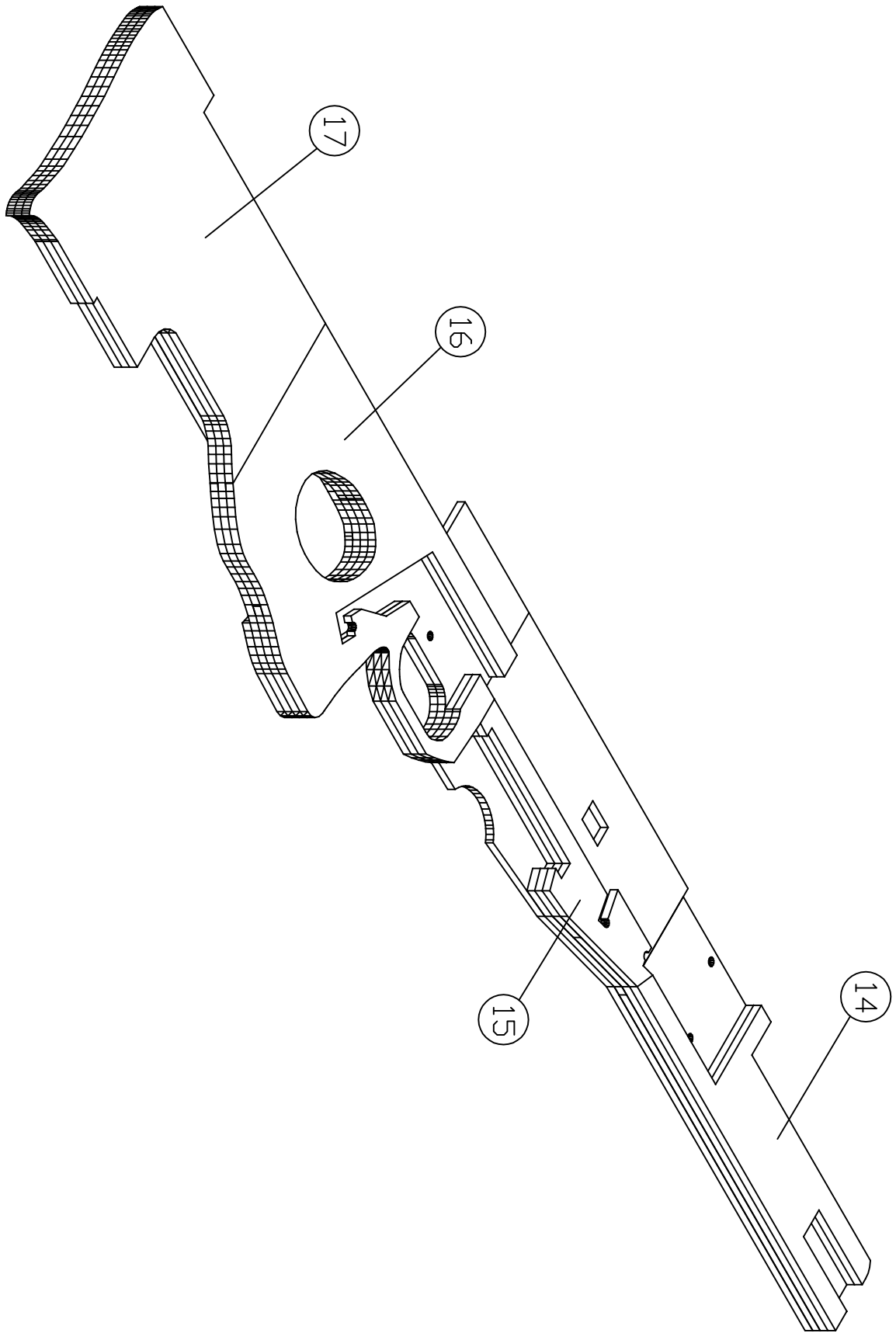

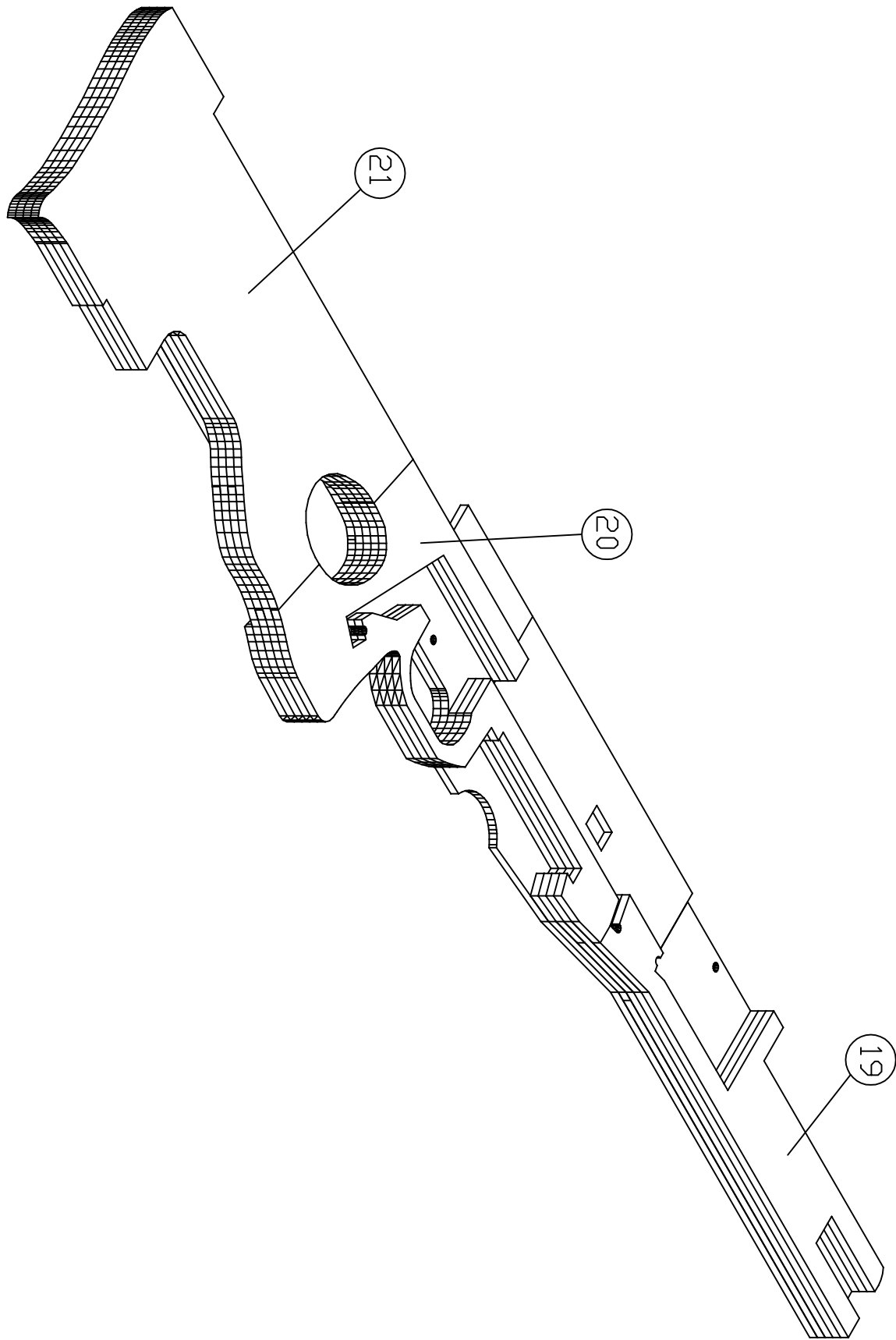

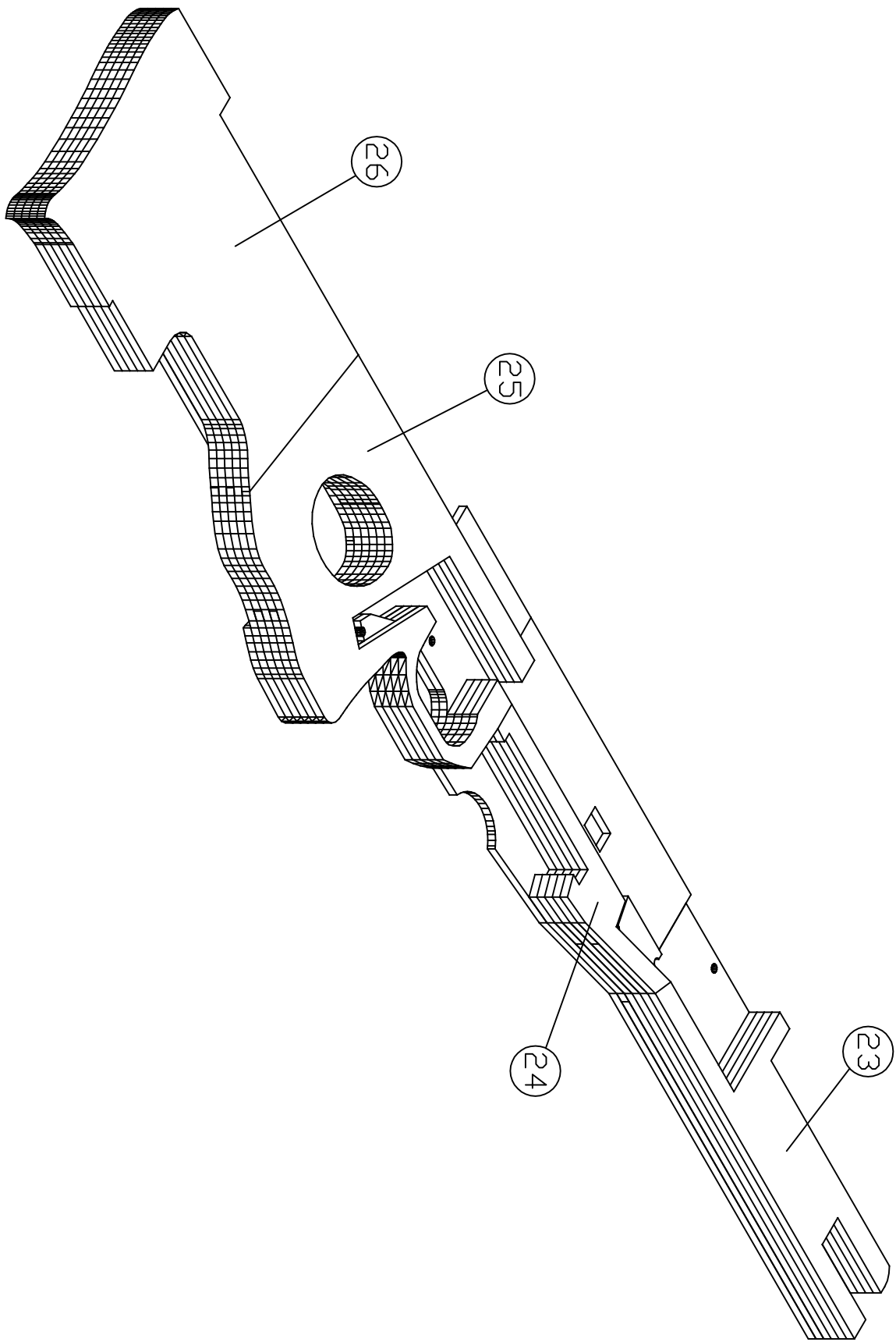



7

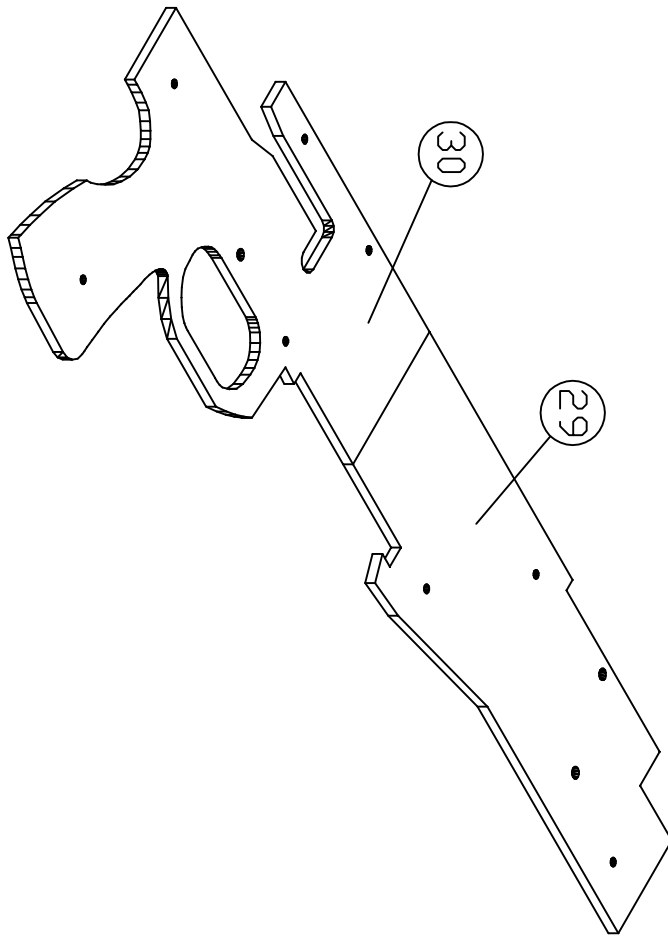

8

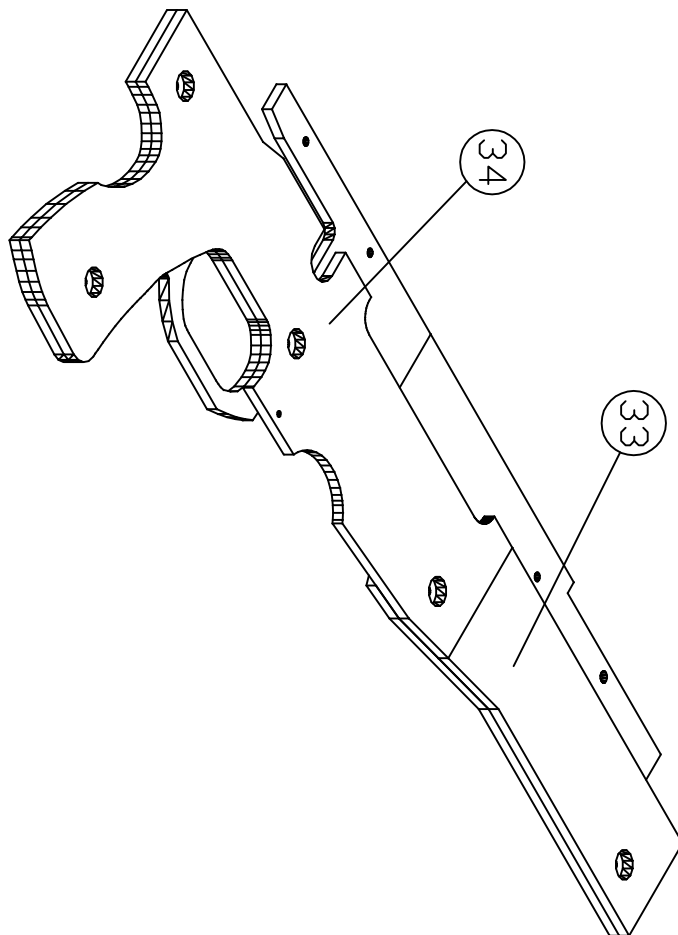

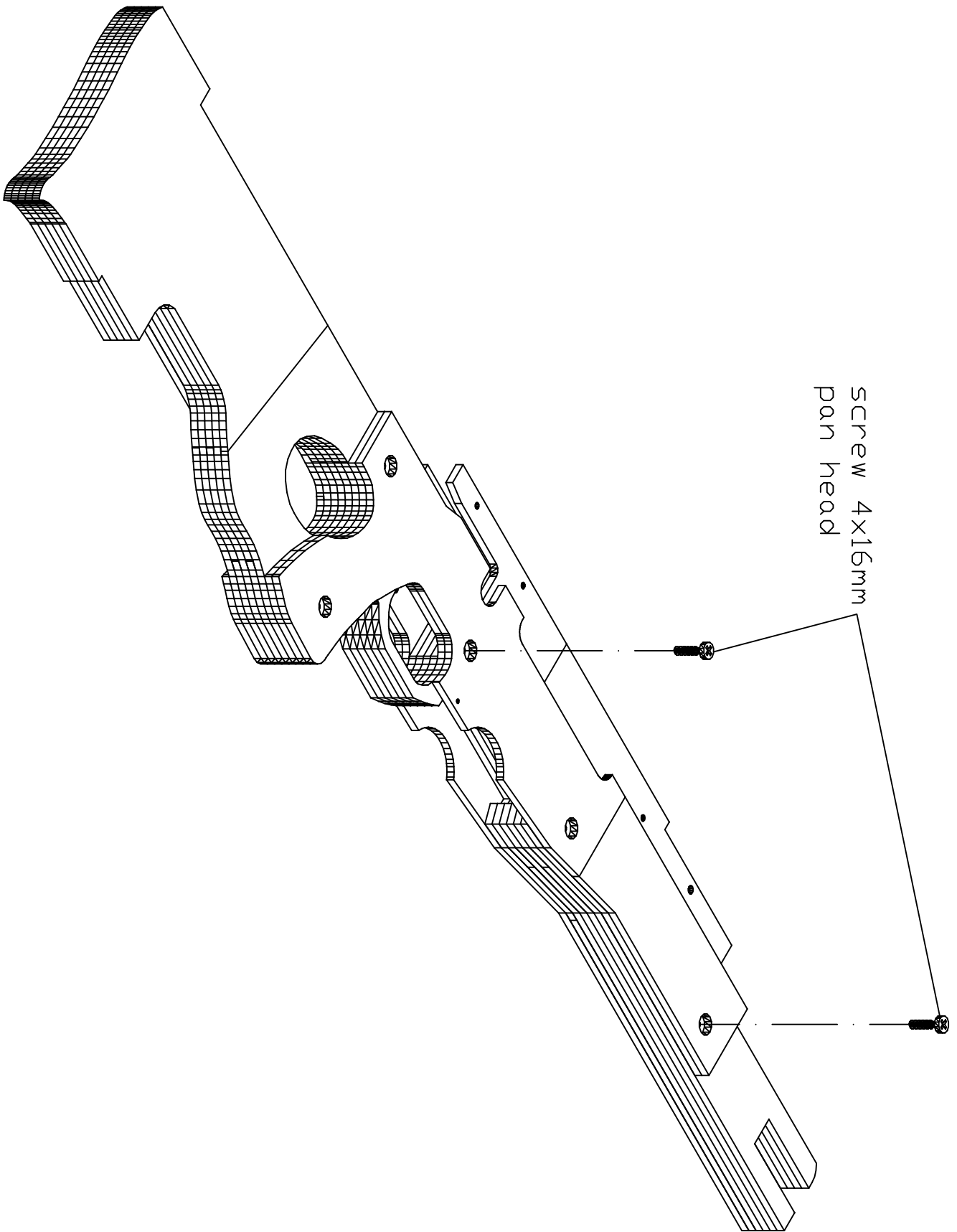

screw 4x16mm  
pan head

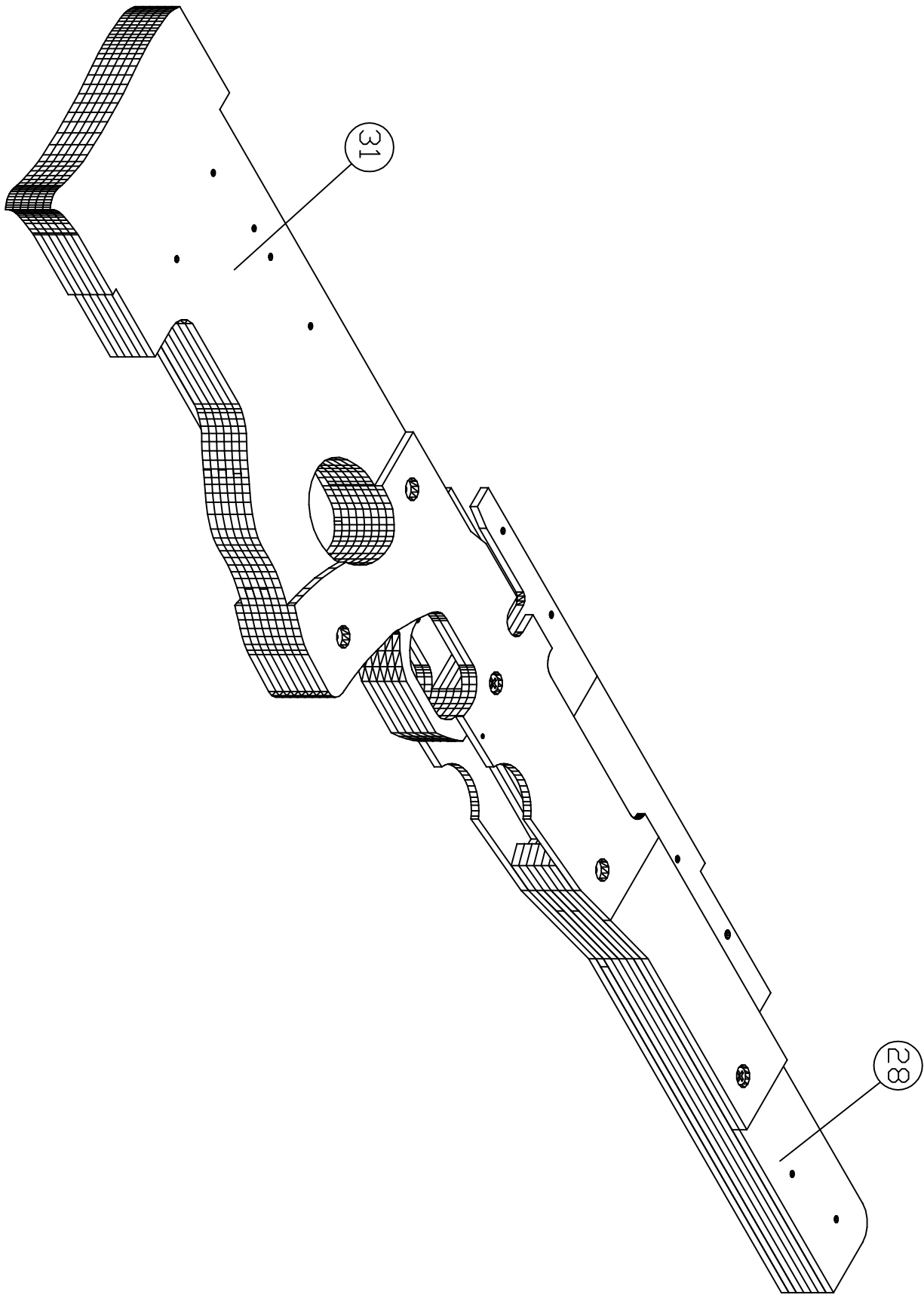

screw 4x16mm  
pan head

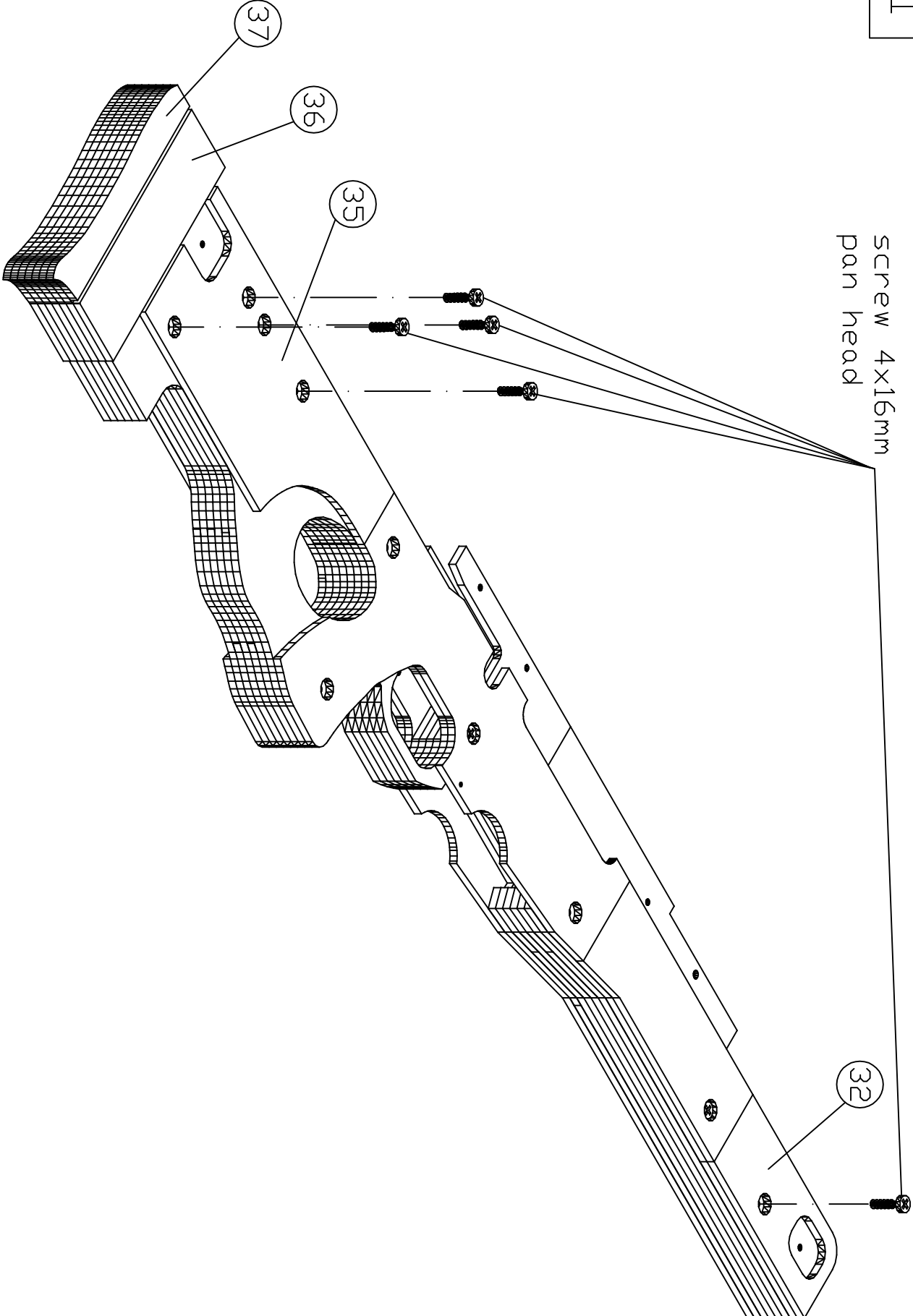

12

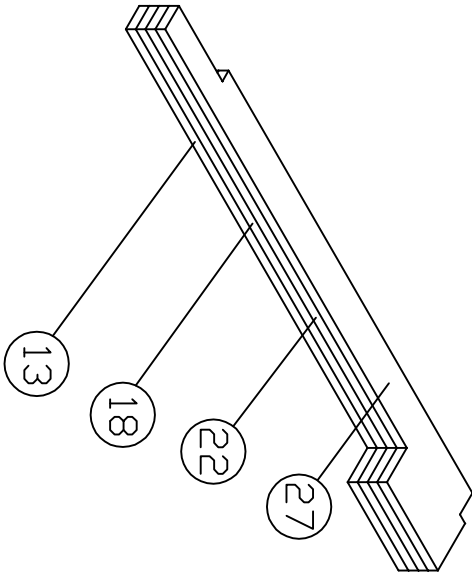

13

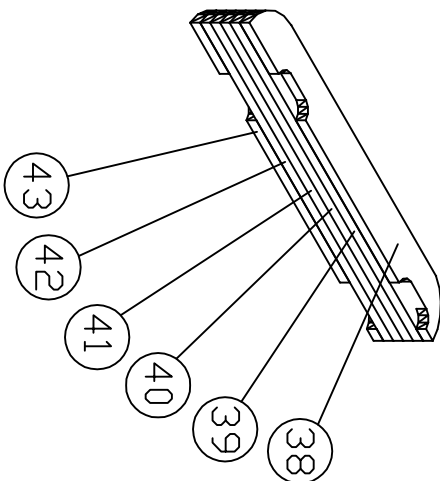

14

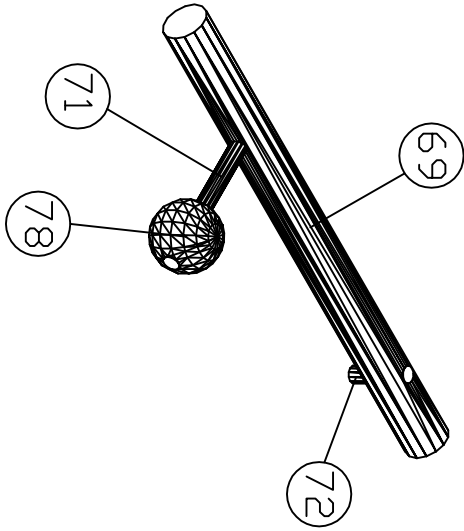

15

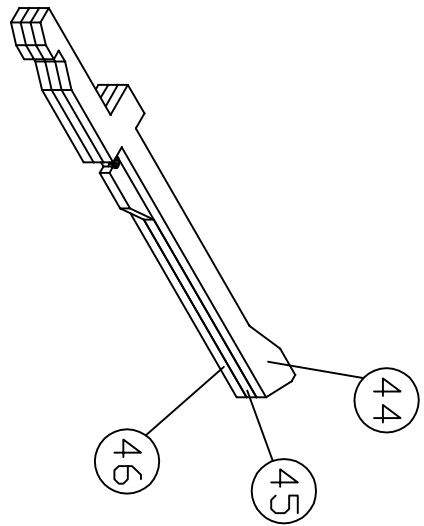

16

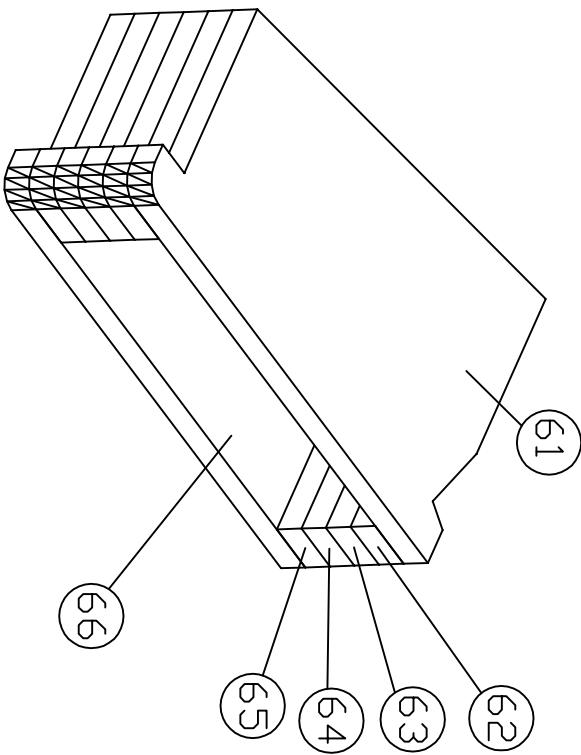

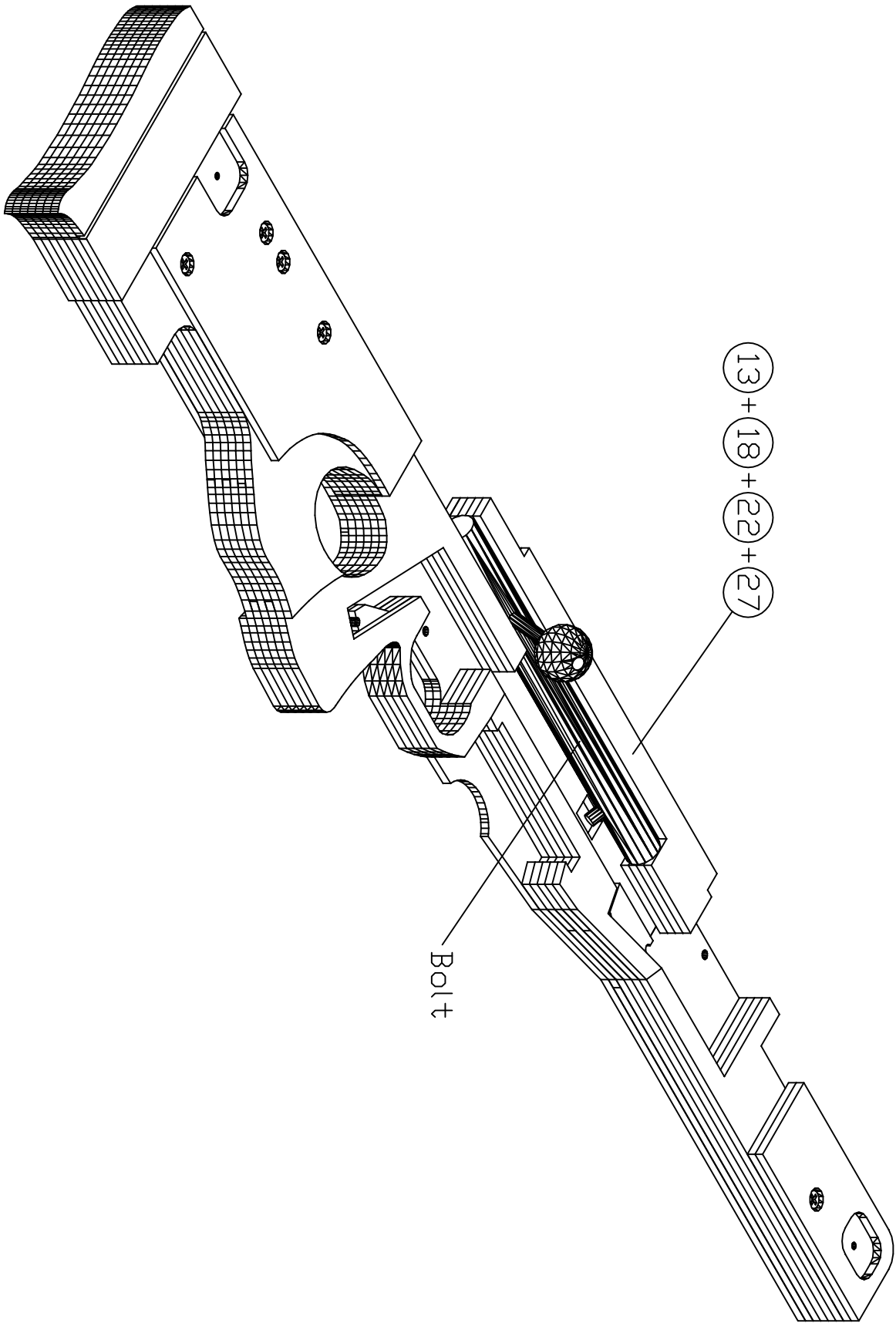

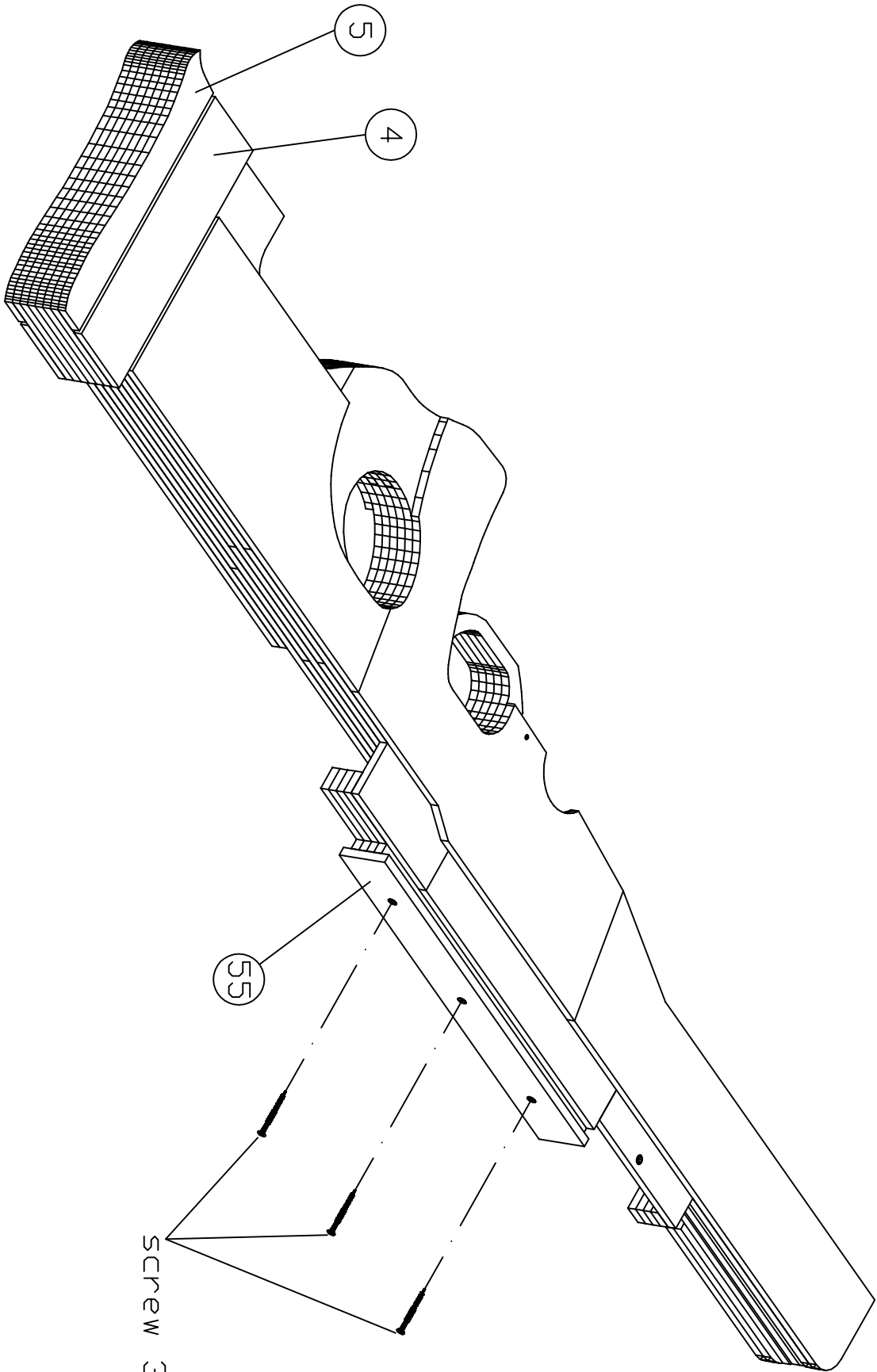

screw 3,5x16mm



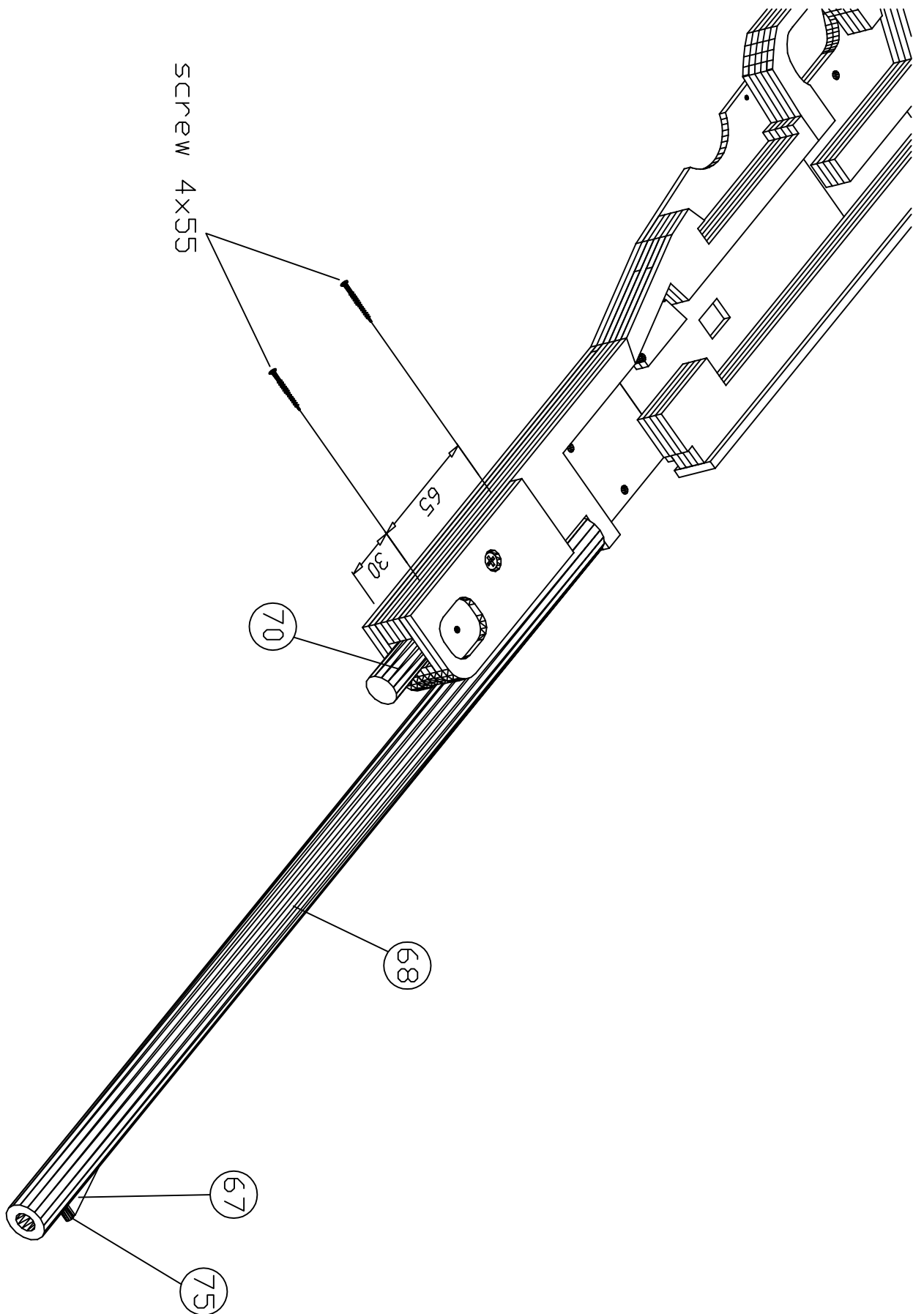

20

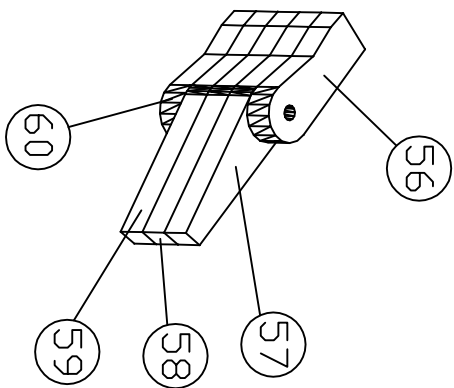

21

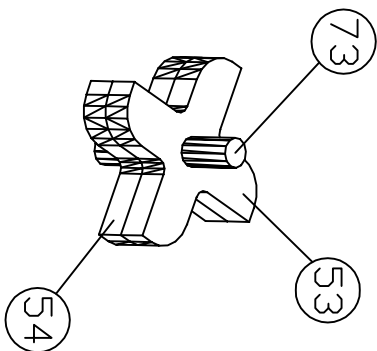

22

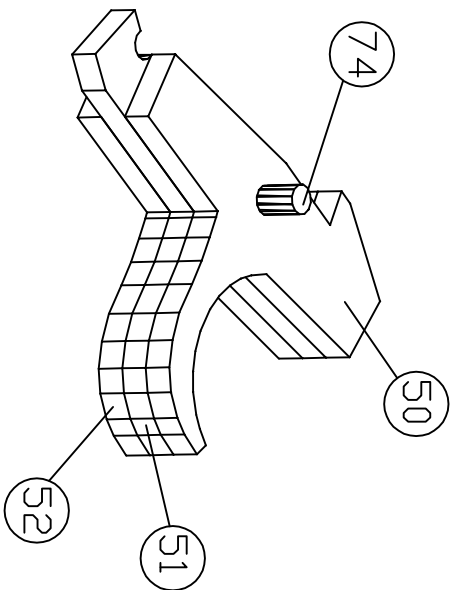

23

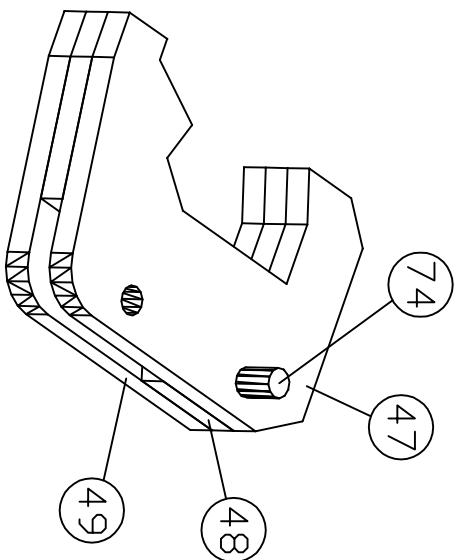

24

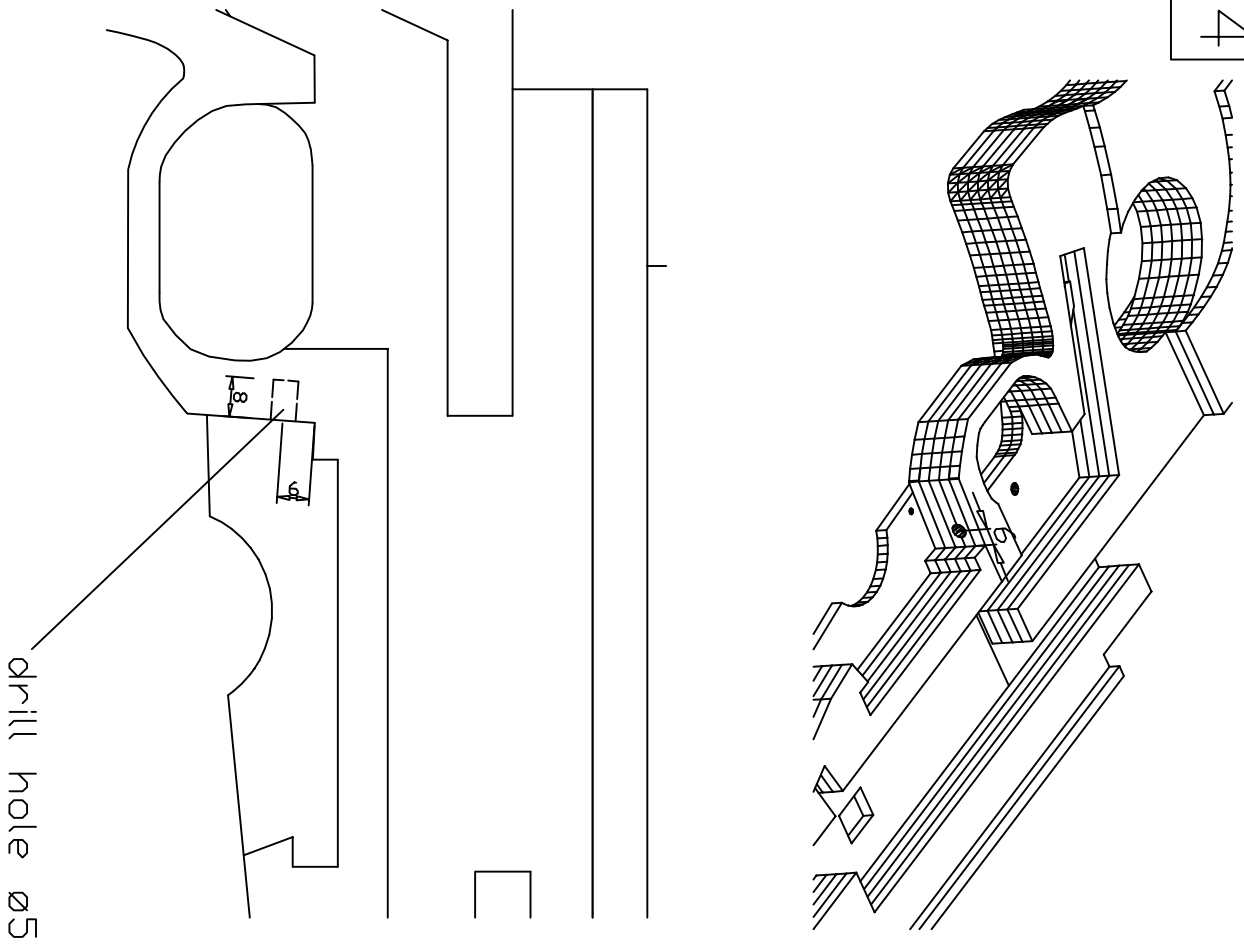

25

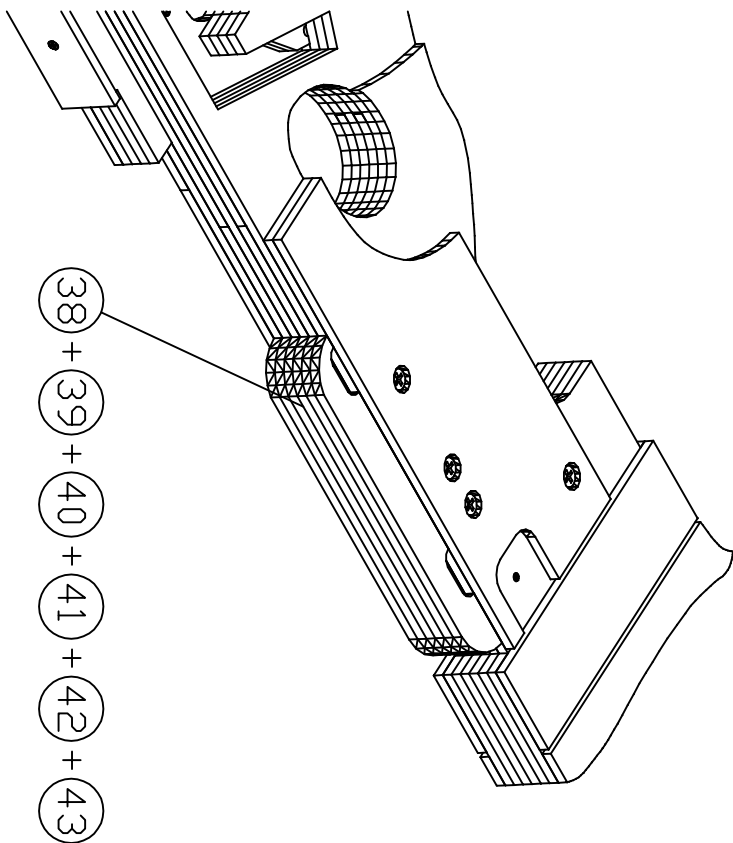

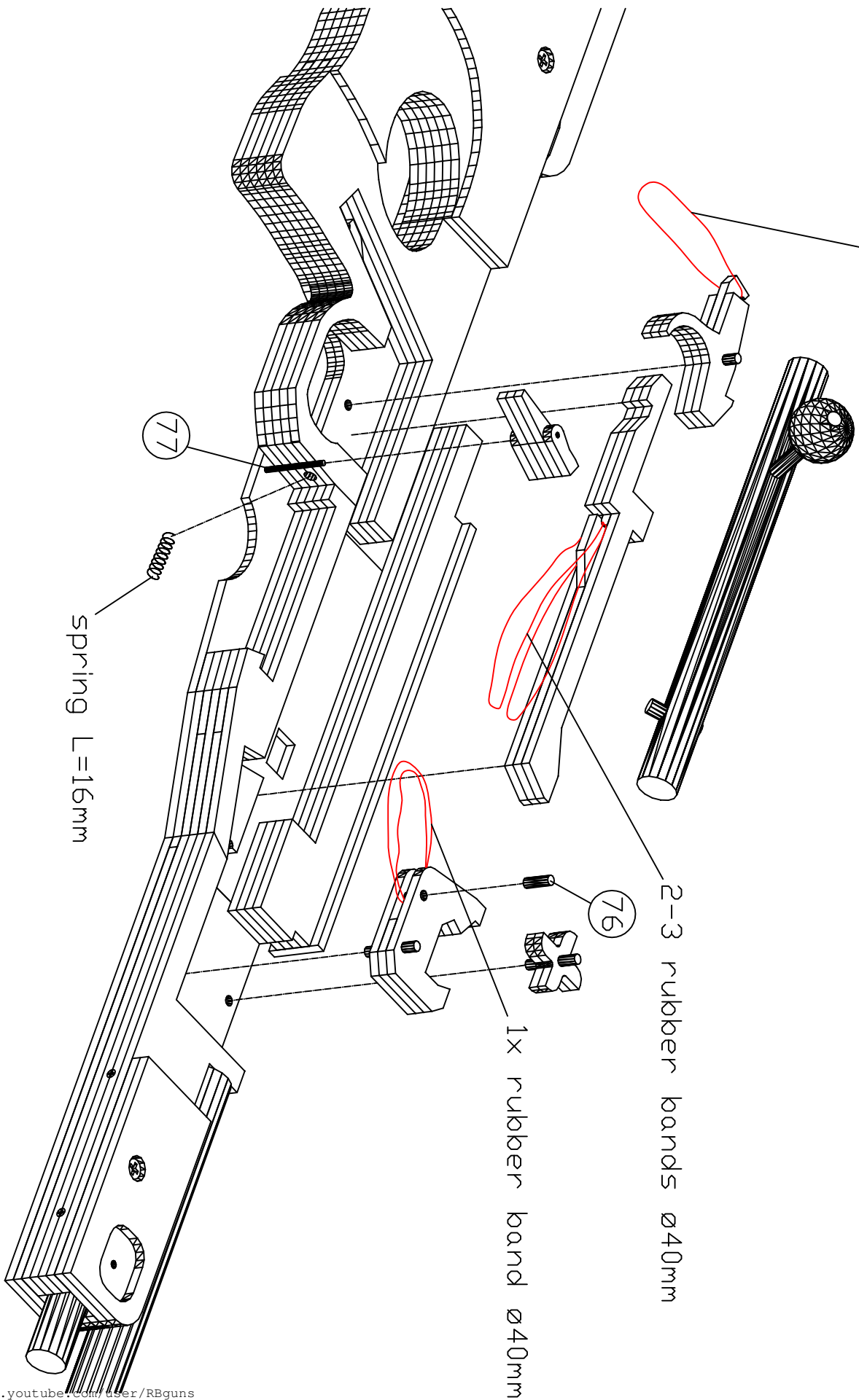

1x rubber band ø40mm

2-3 rubber bands ø40mm

1x rubber band ø40mm

spring L=16mm

77

76

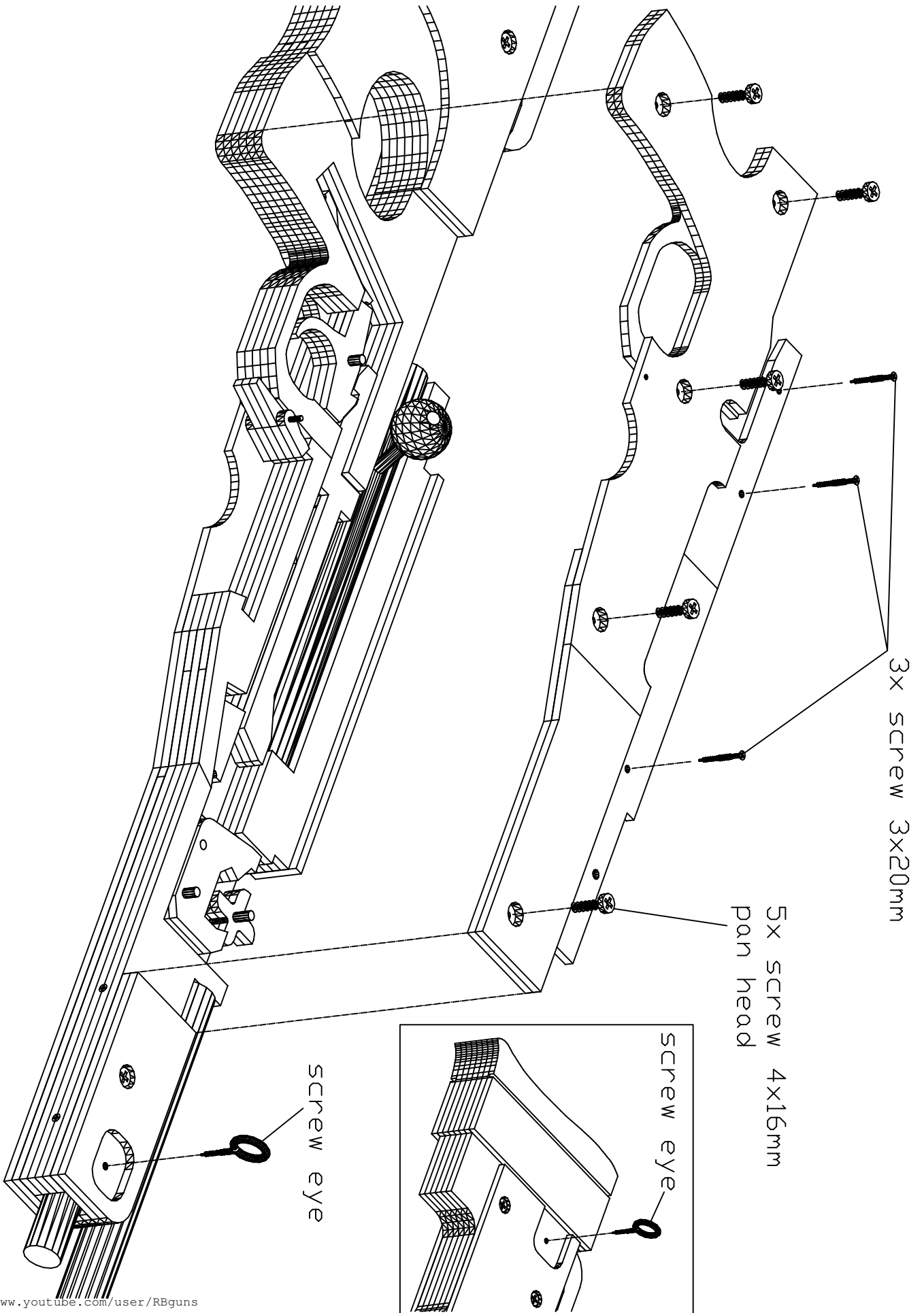

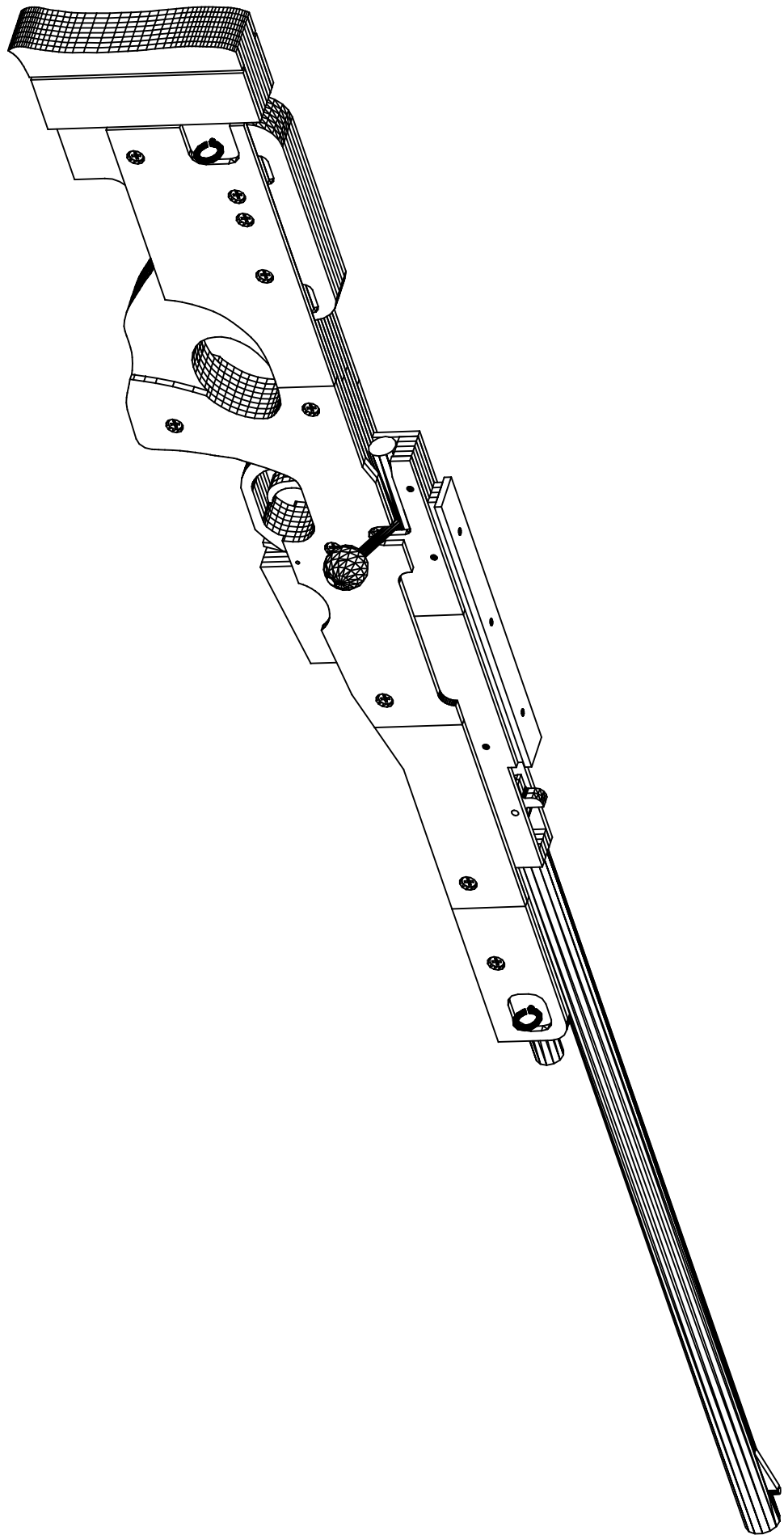
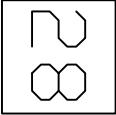

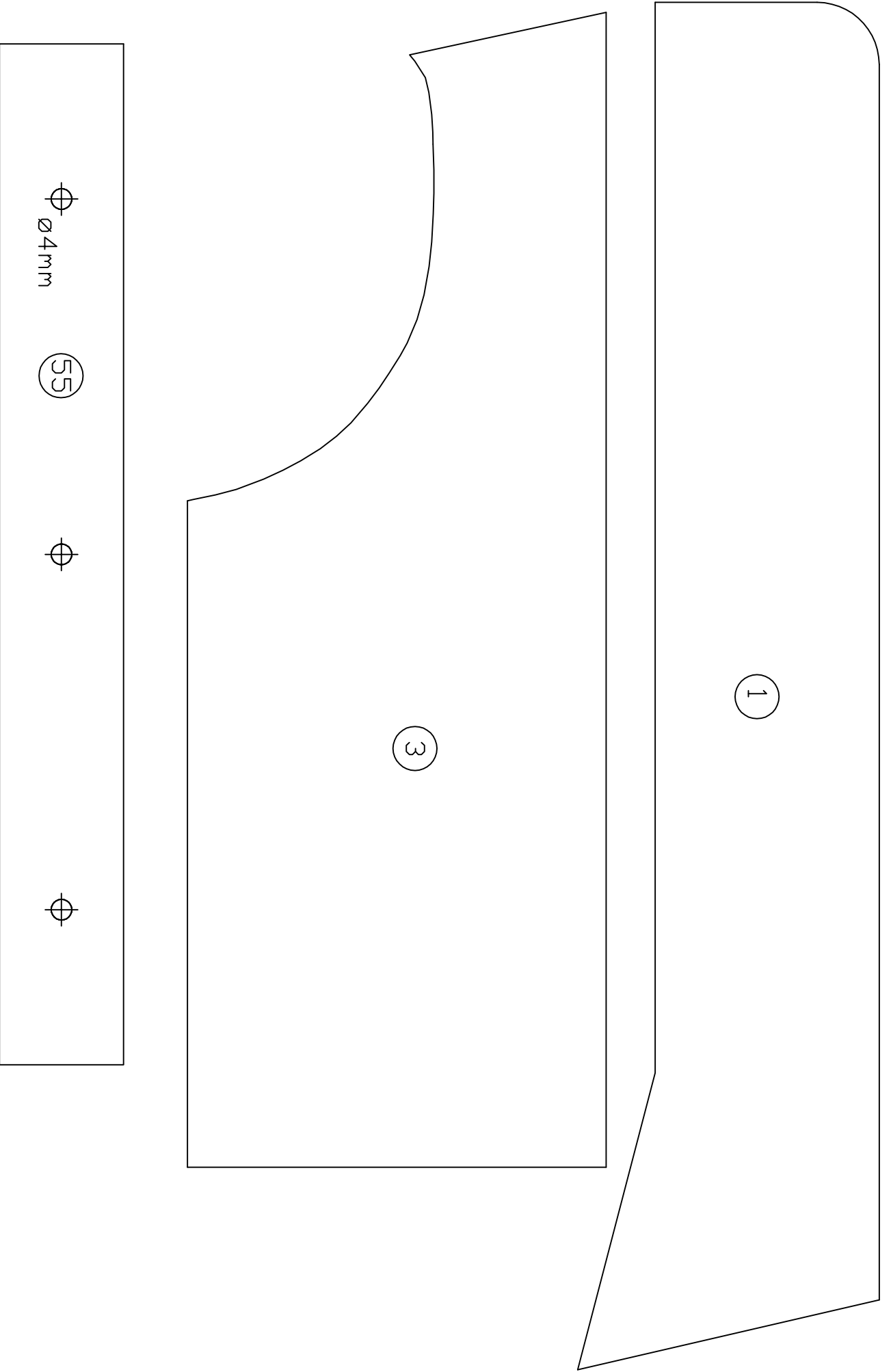

Ø 4mm

55

Ø

Ø

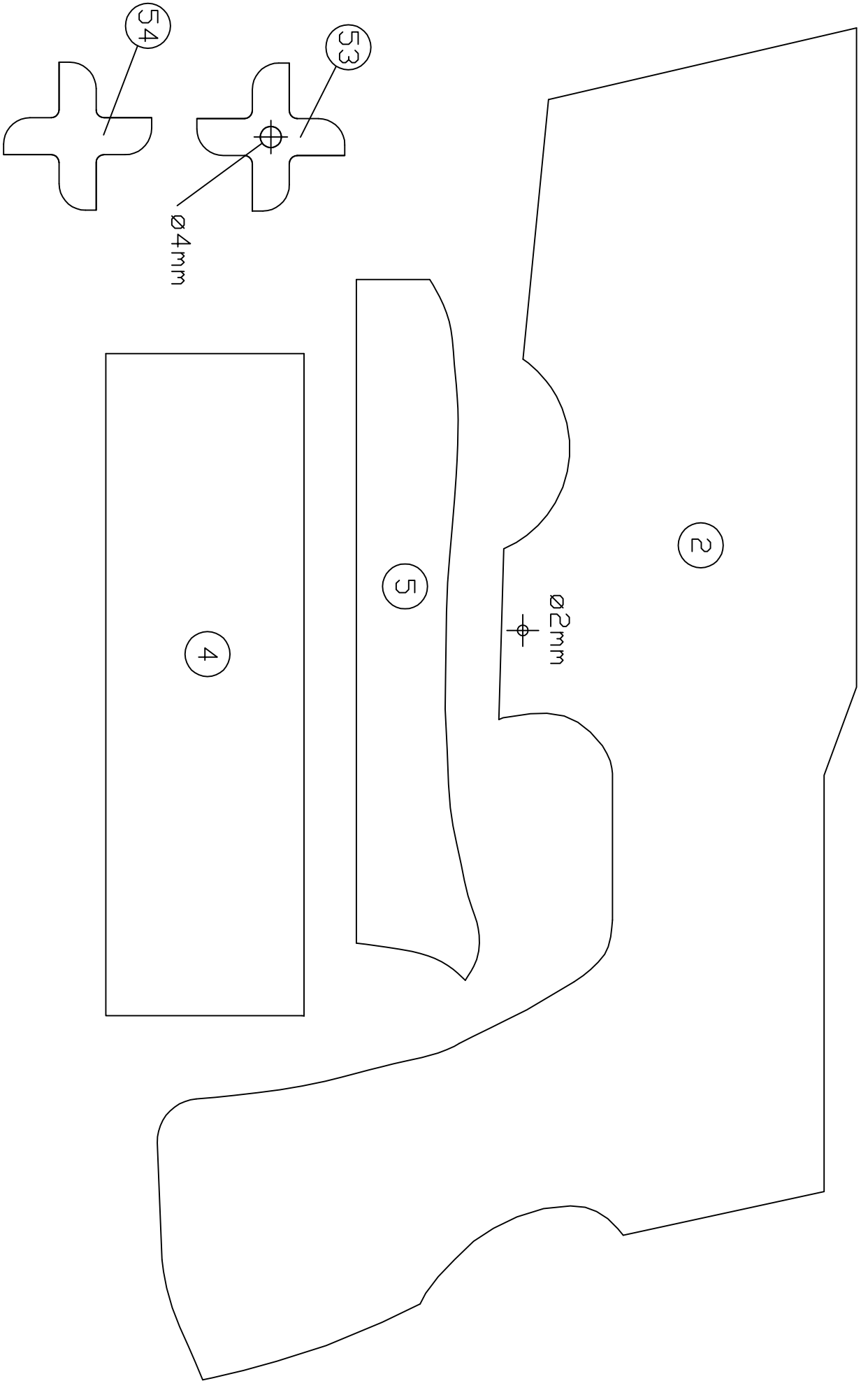



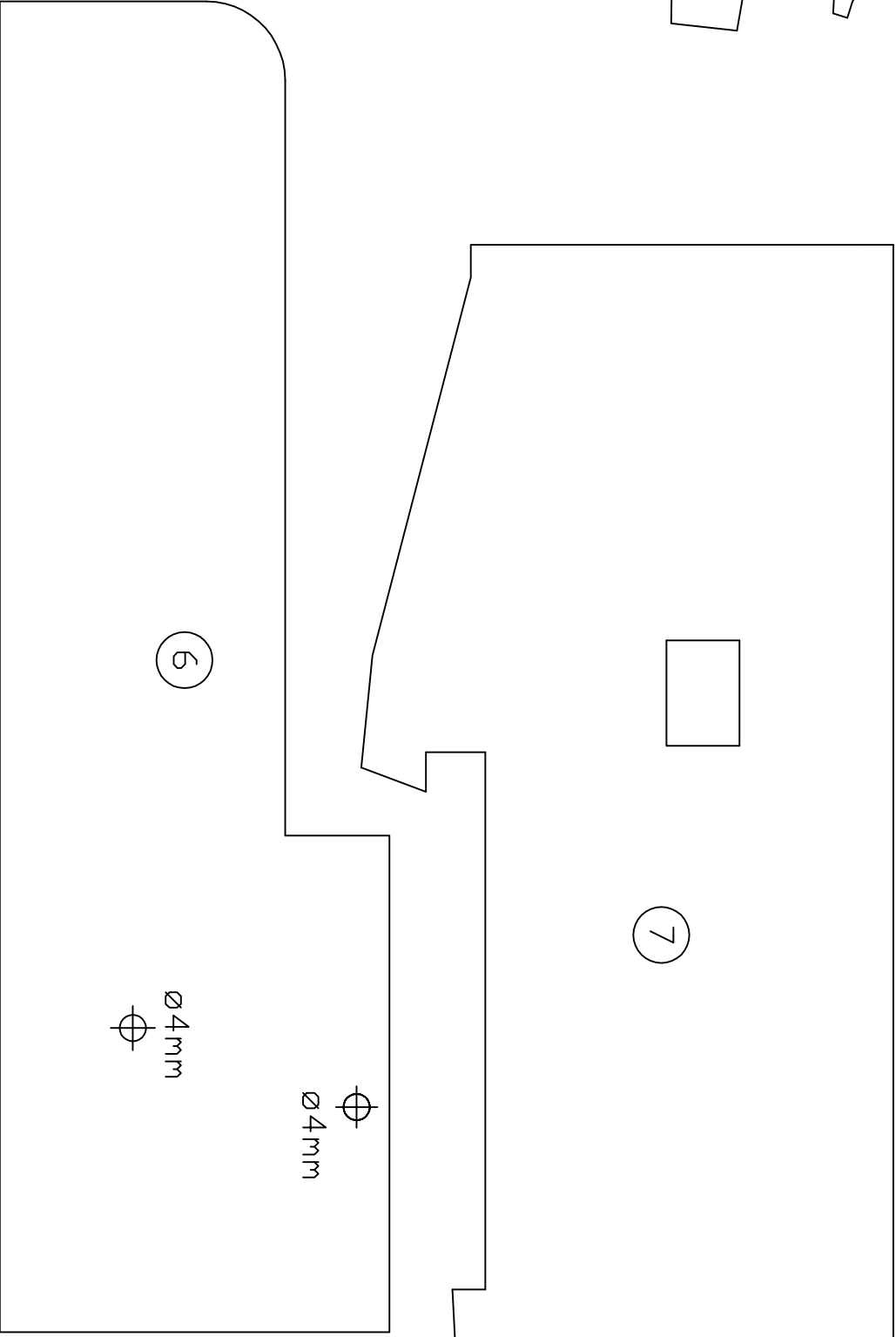
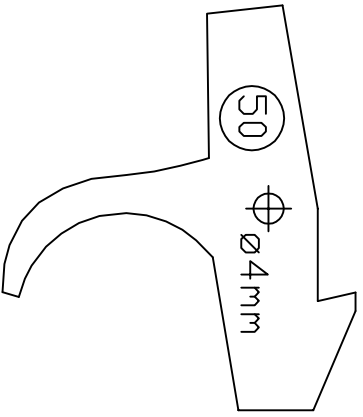
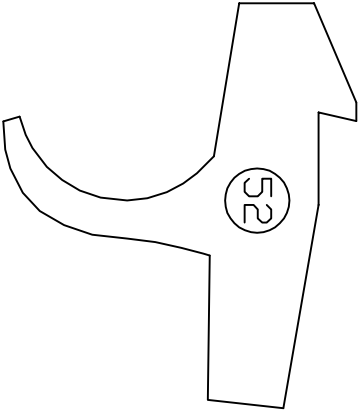
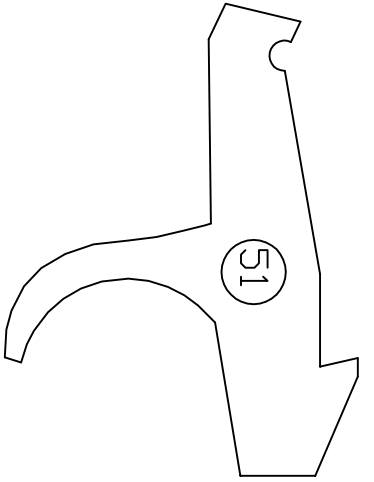

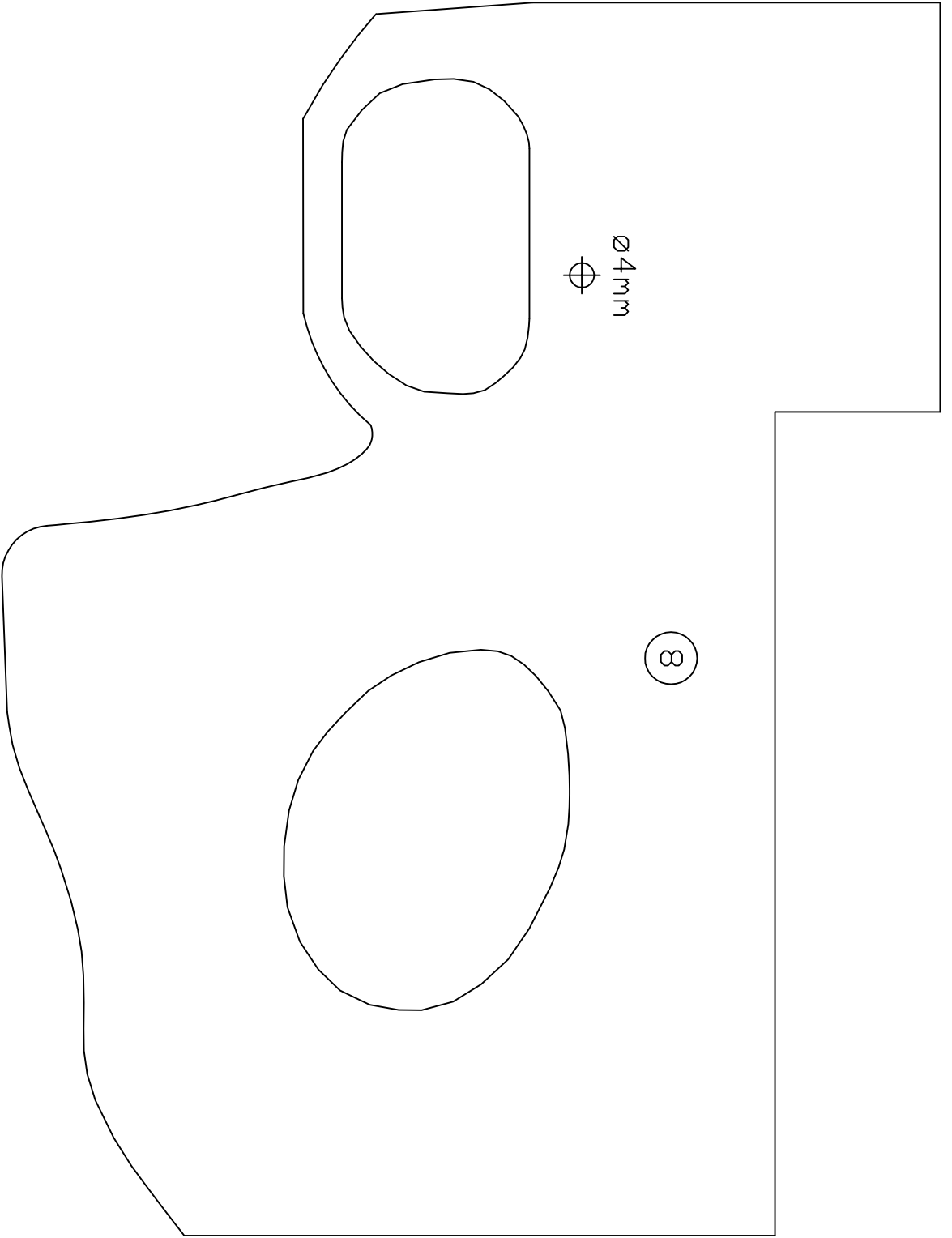

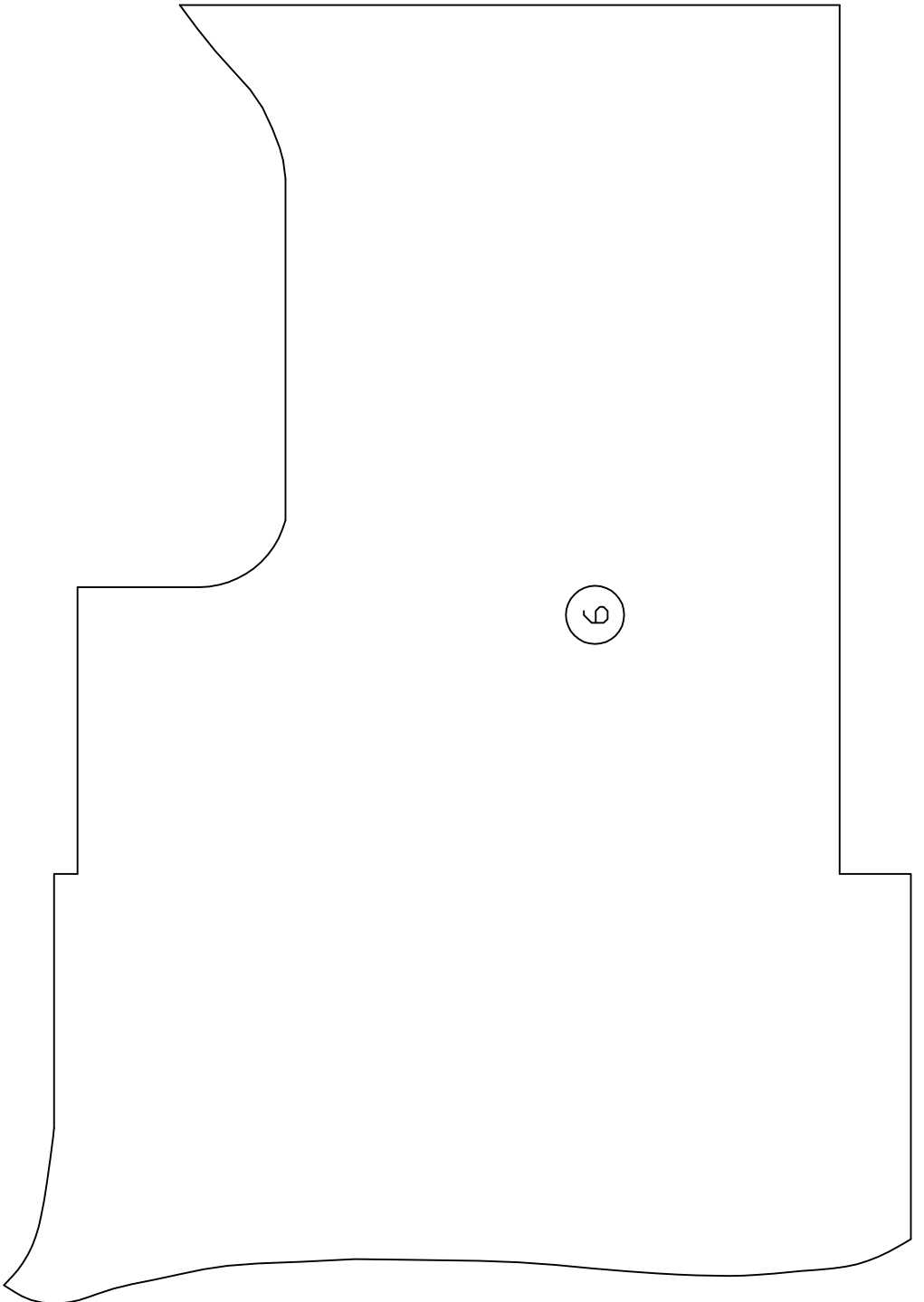
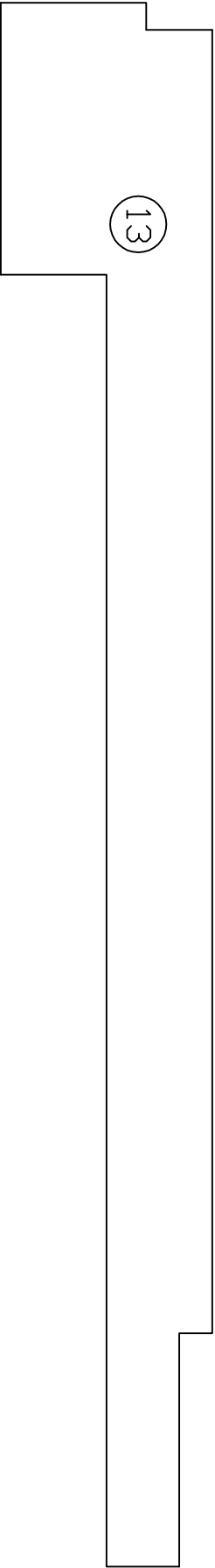

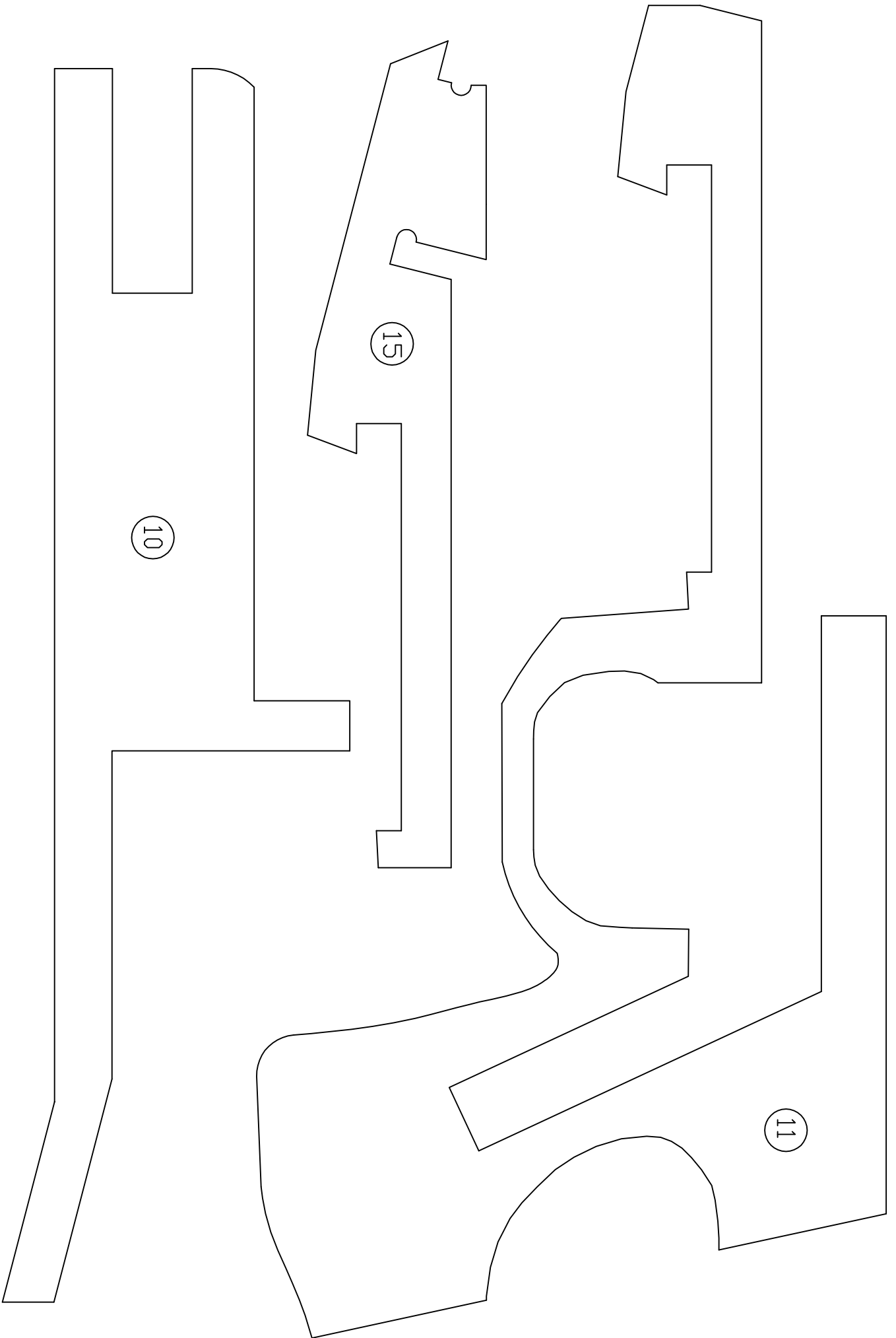

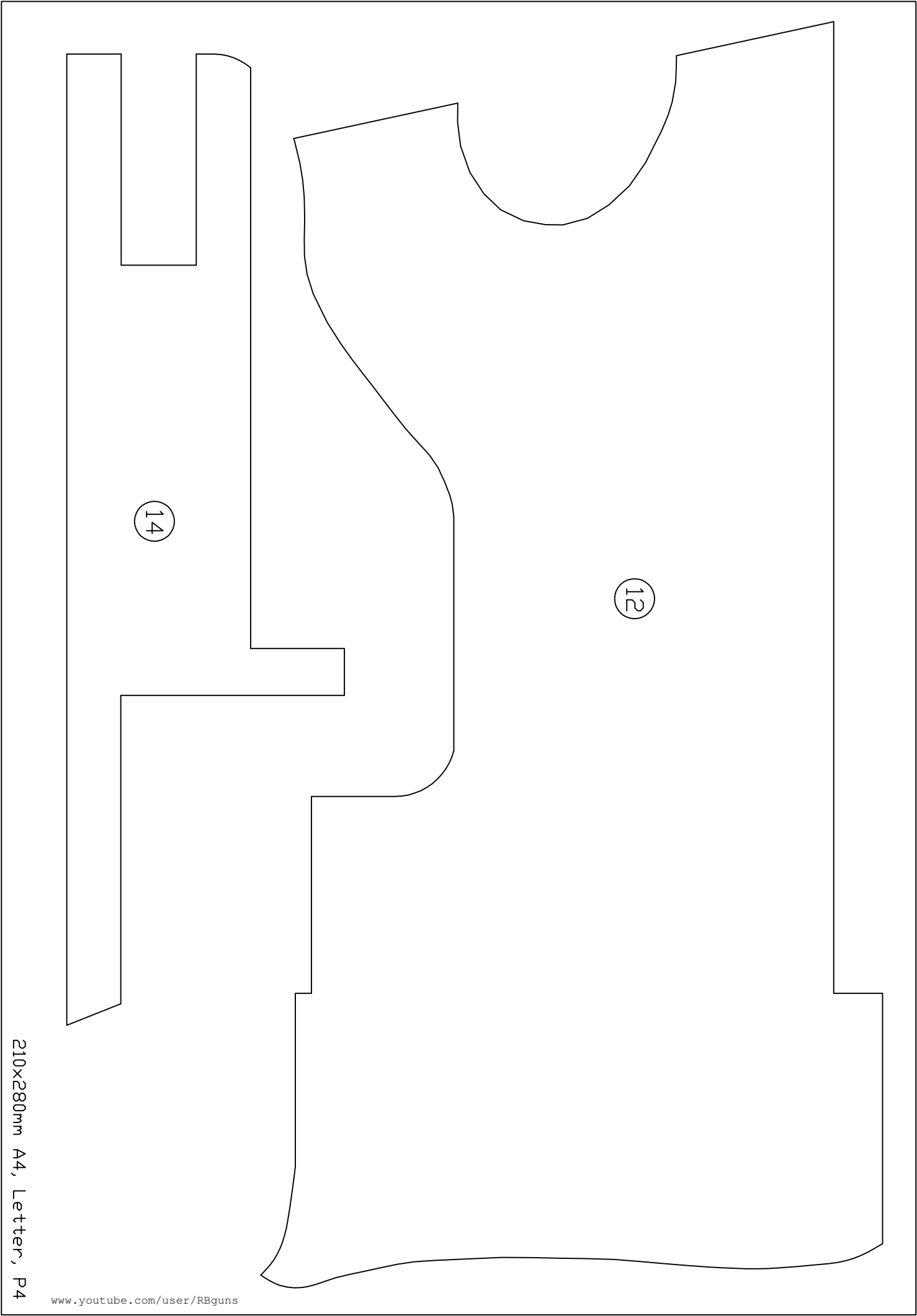

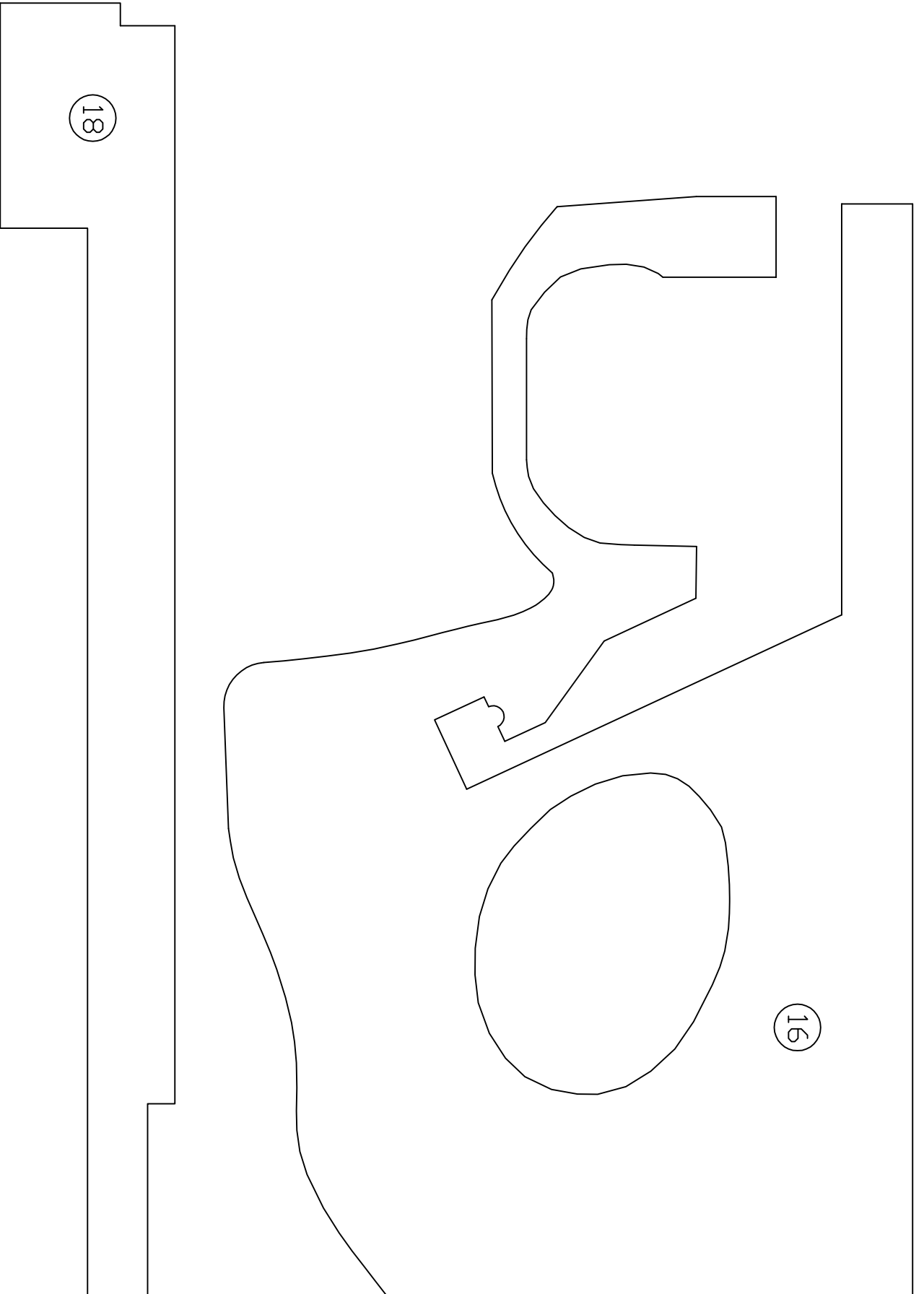

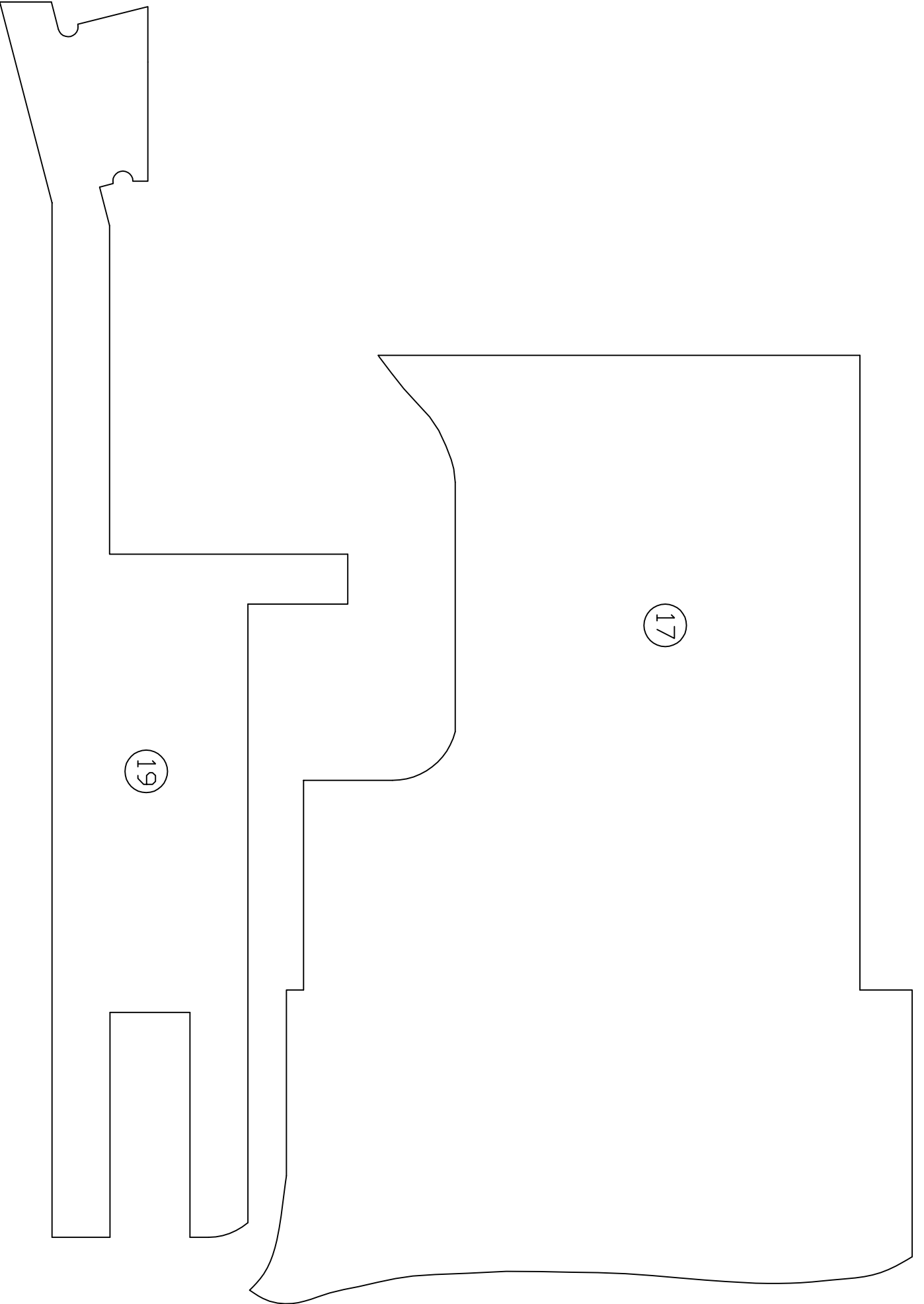

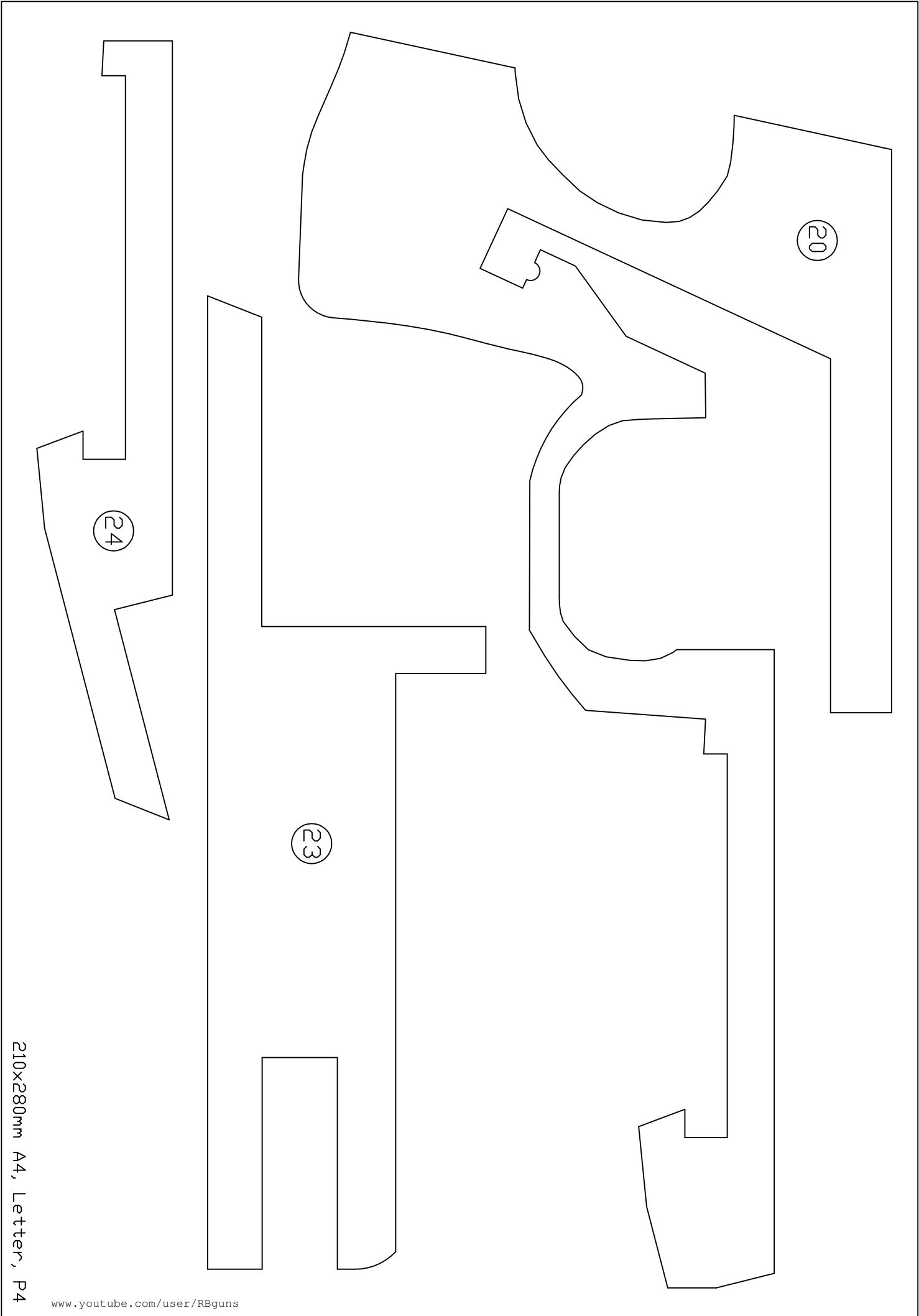

20

23

24



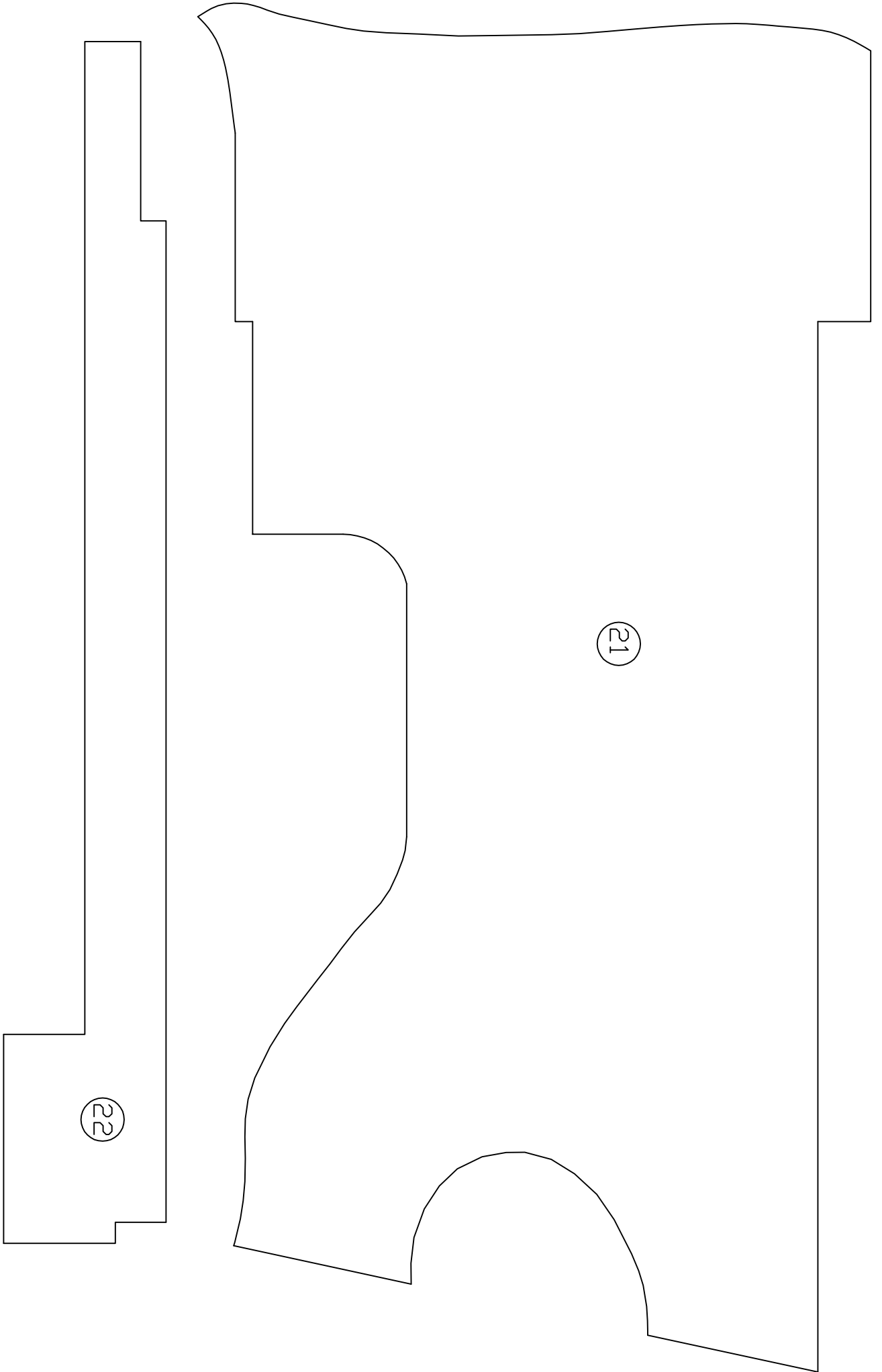

21

22

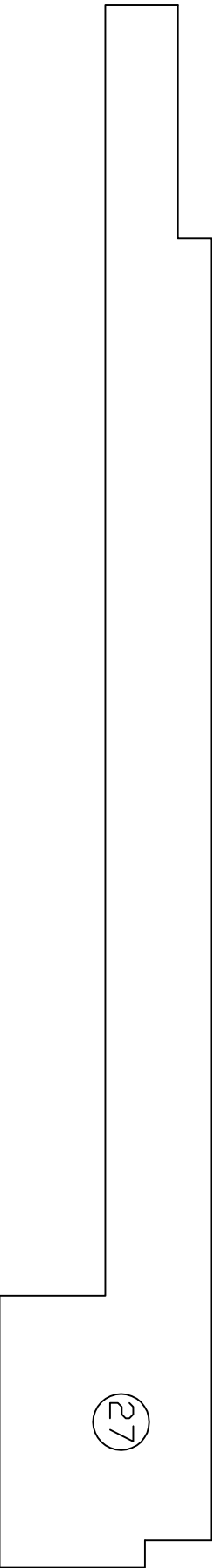
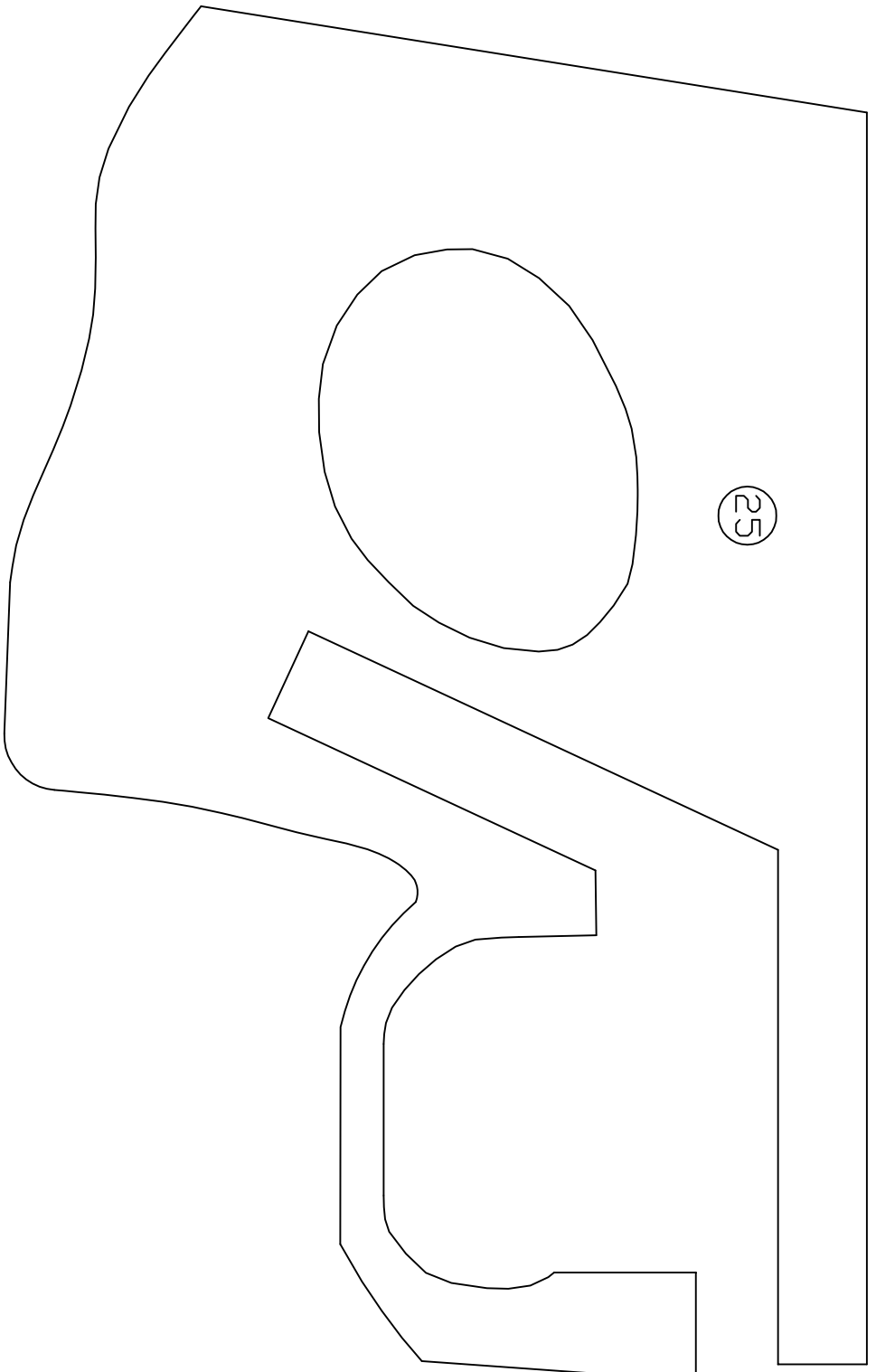

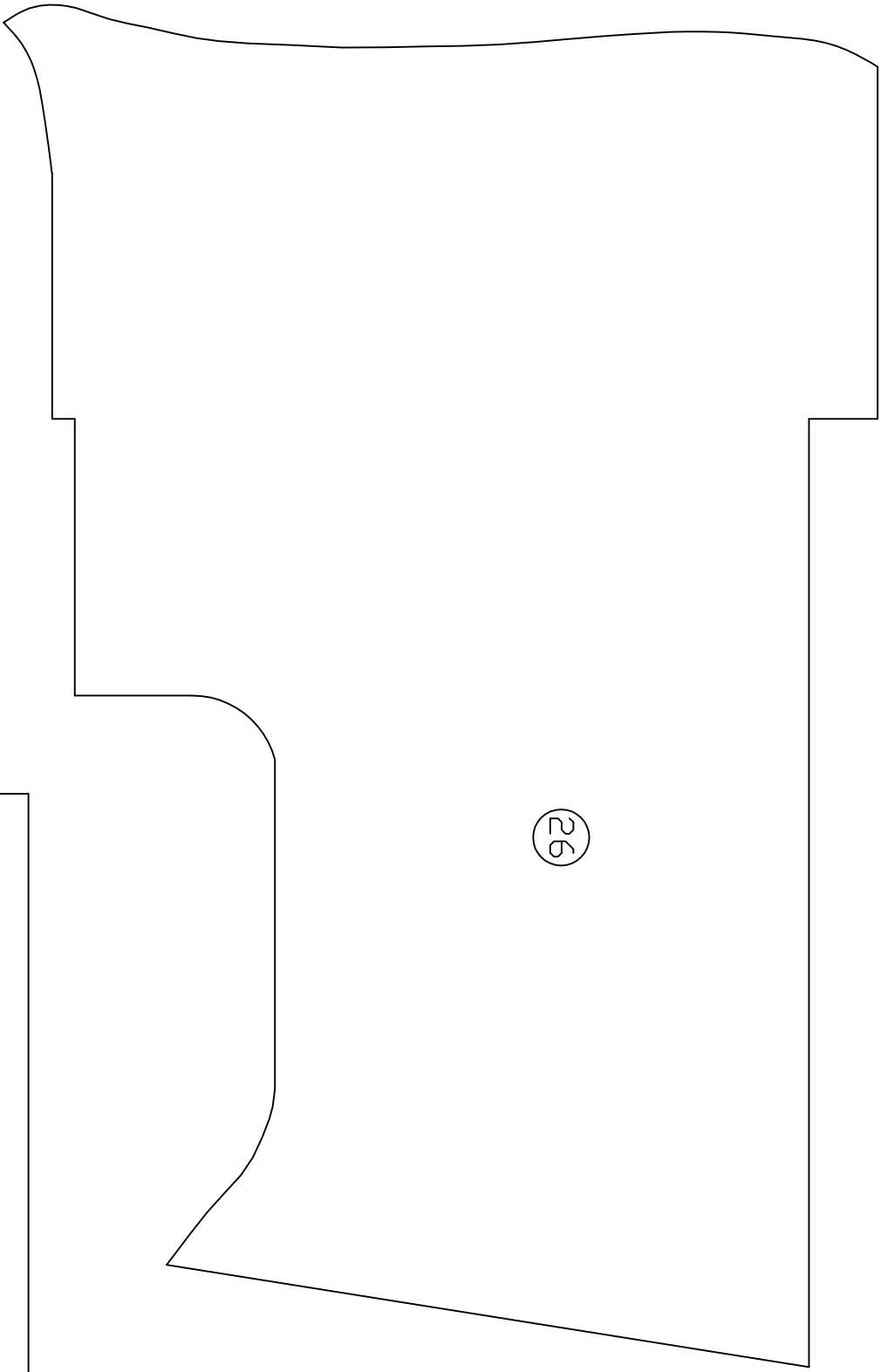

26

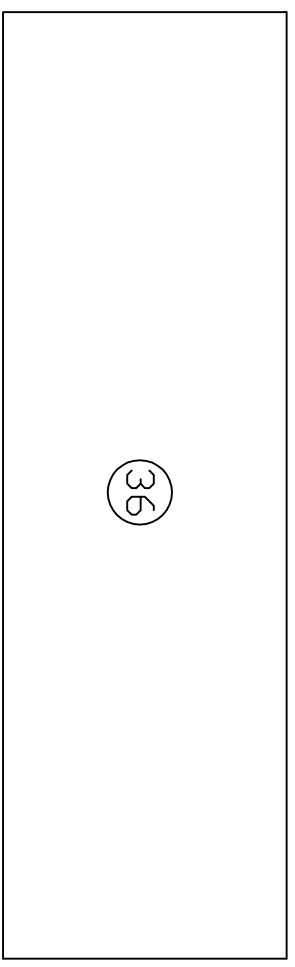

36

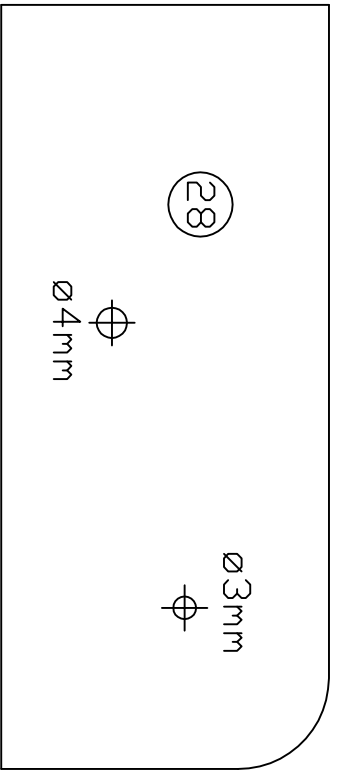

28

∅4mm

∅3mm

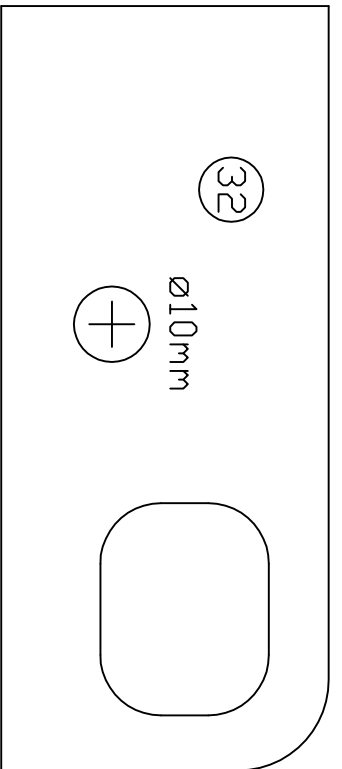

32

∅10mm

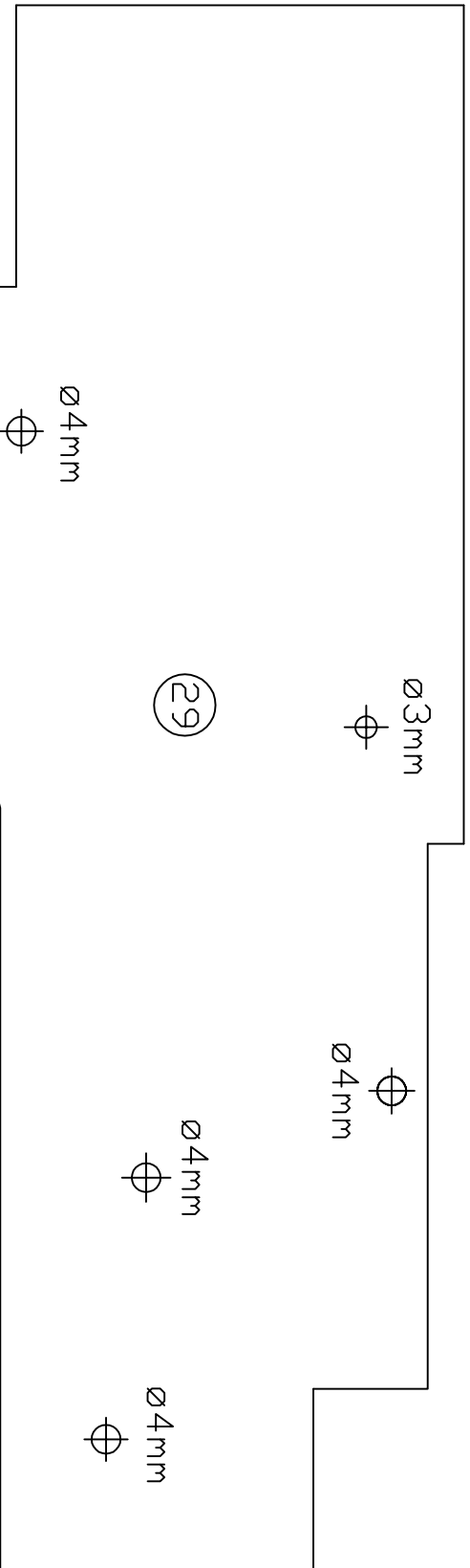
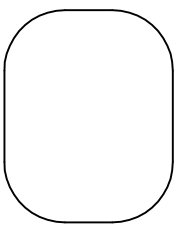

29

∅3mm

∅4mm

∅4mm

∅4mm



∅4mm

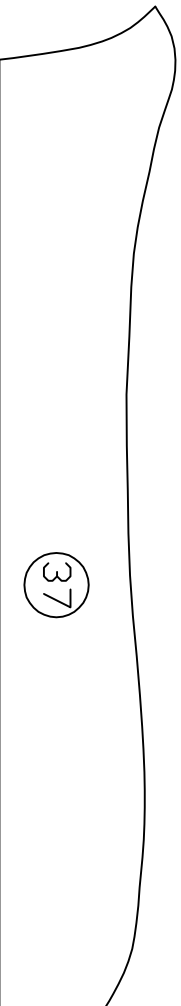

37

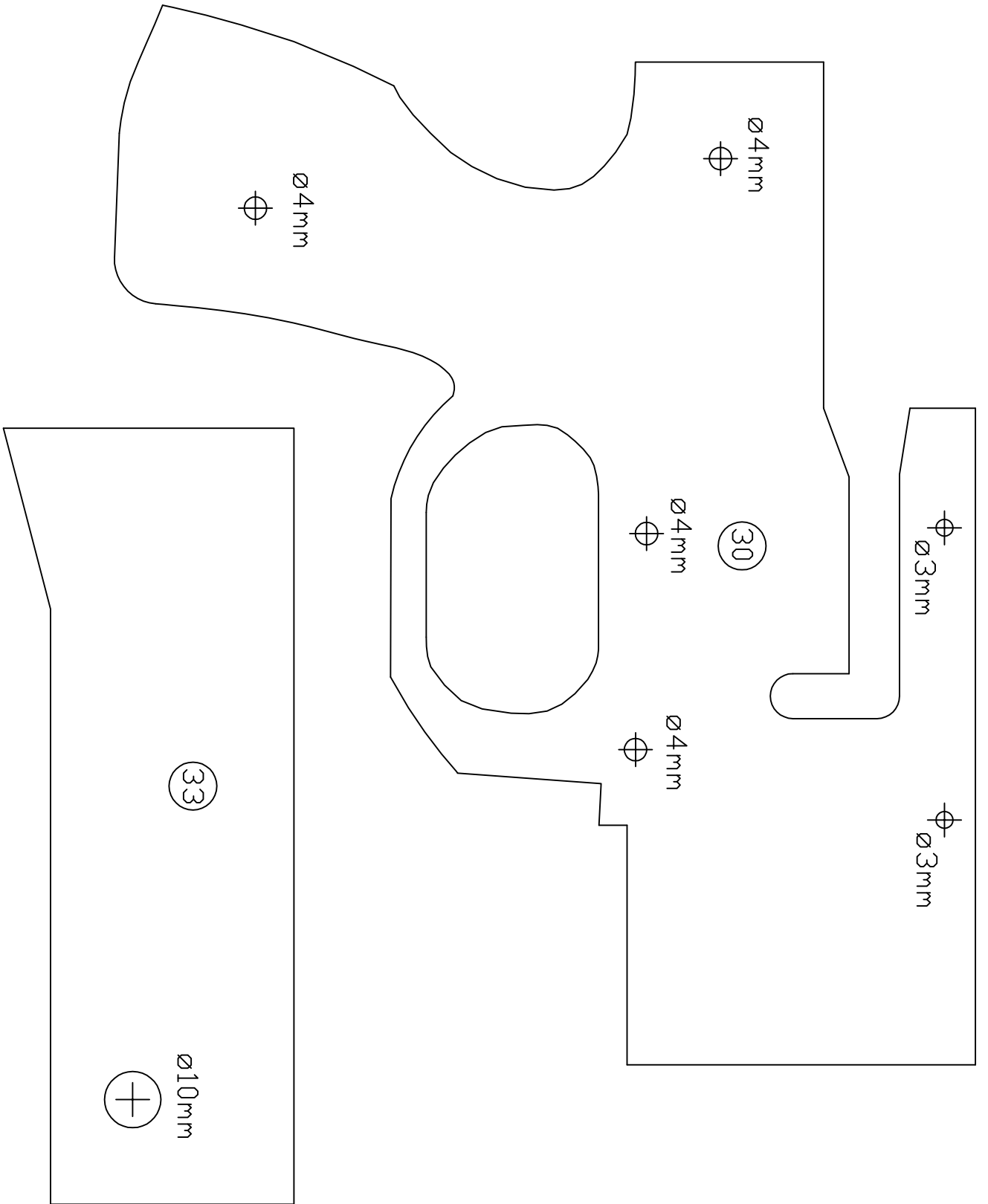

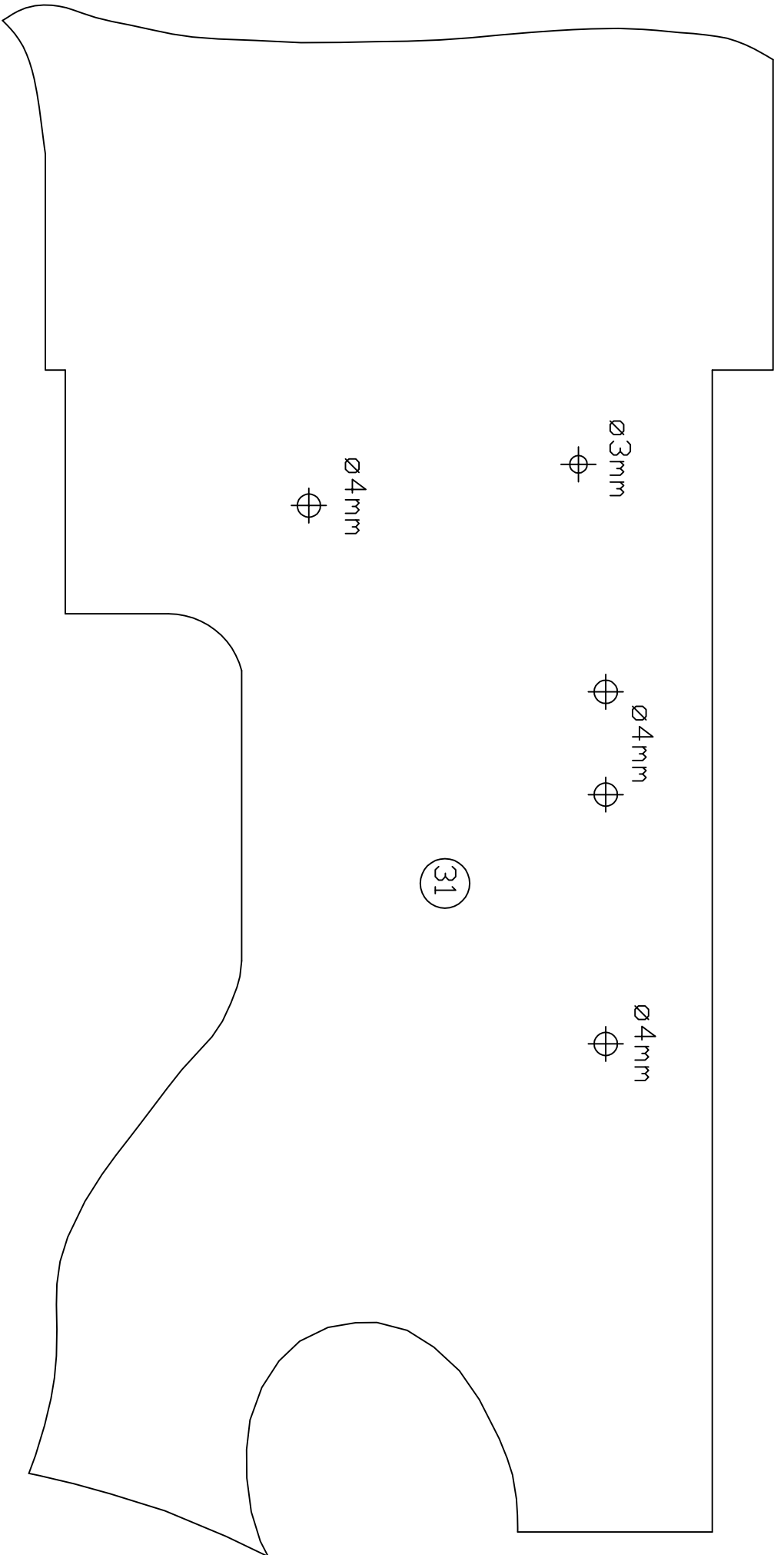

∅3mm

∅4mm

∅4mm

∅4mm

31

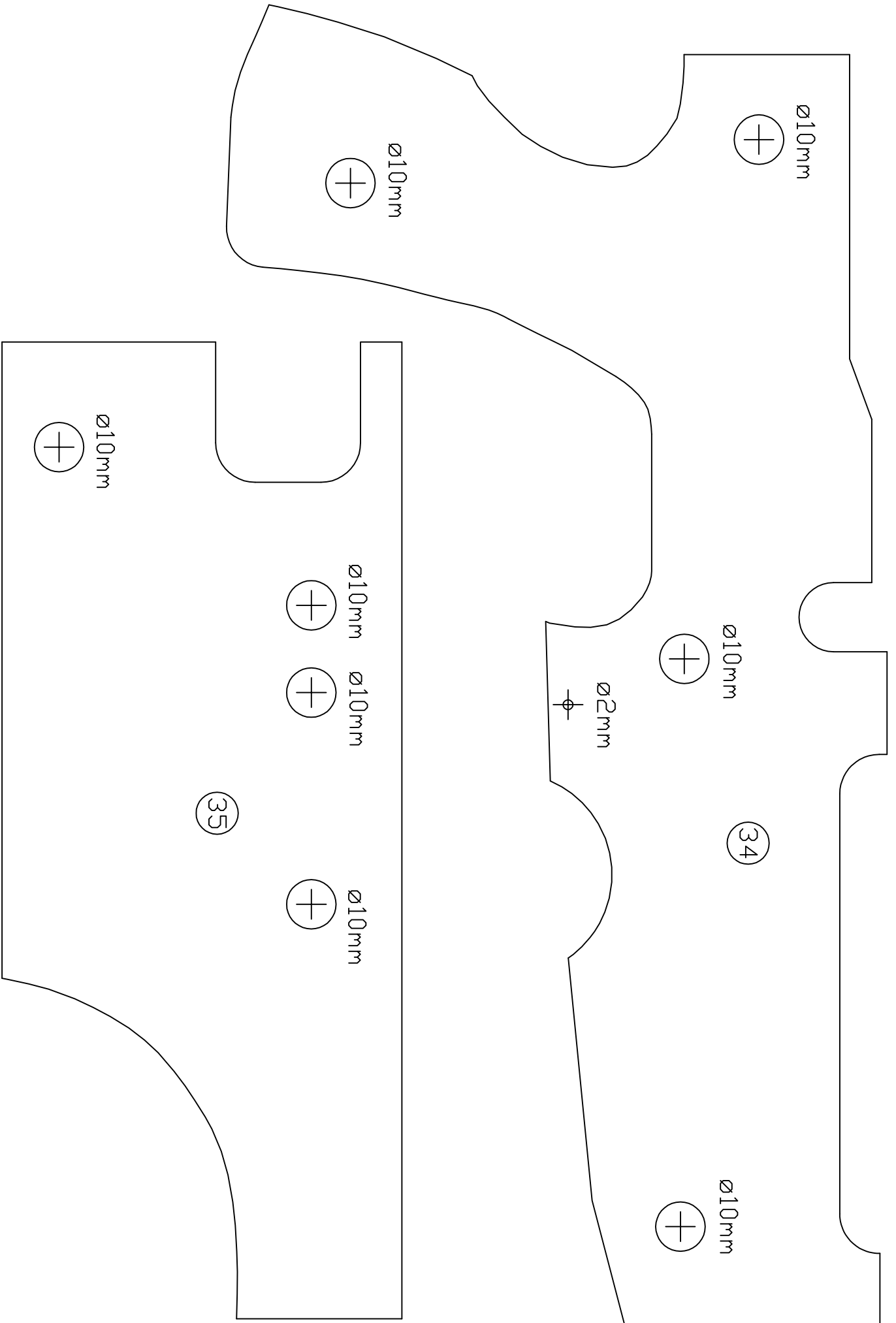

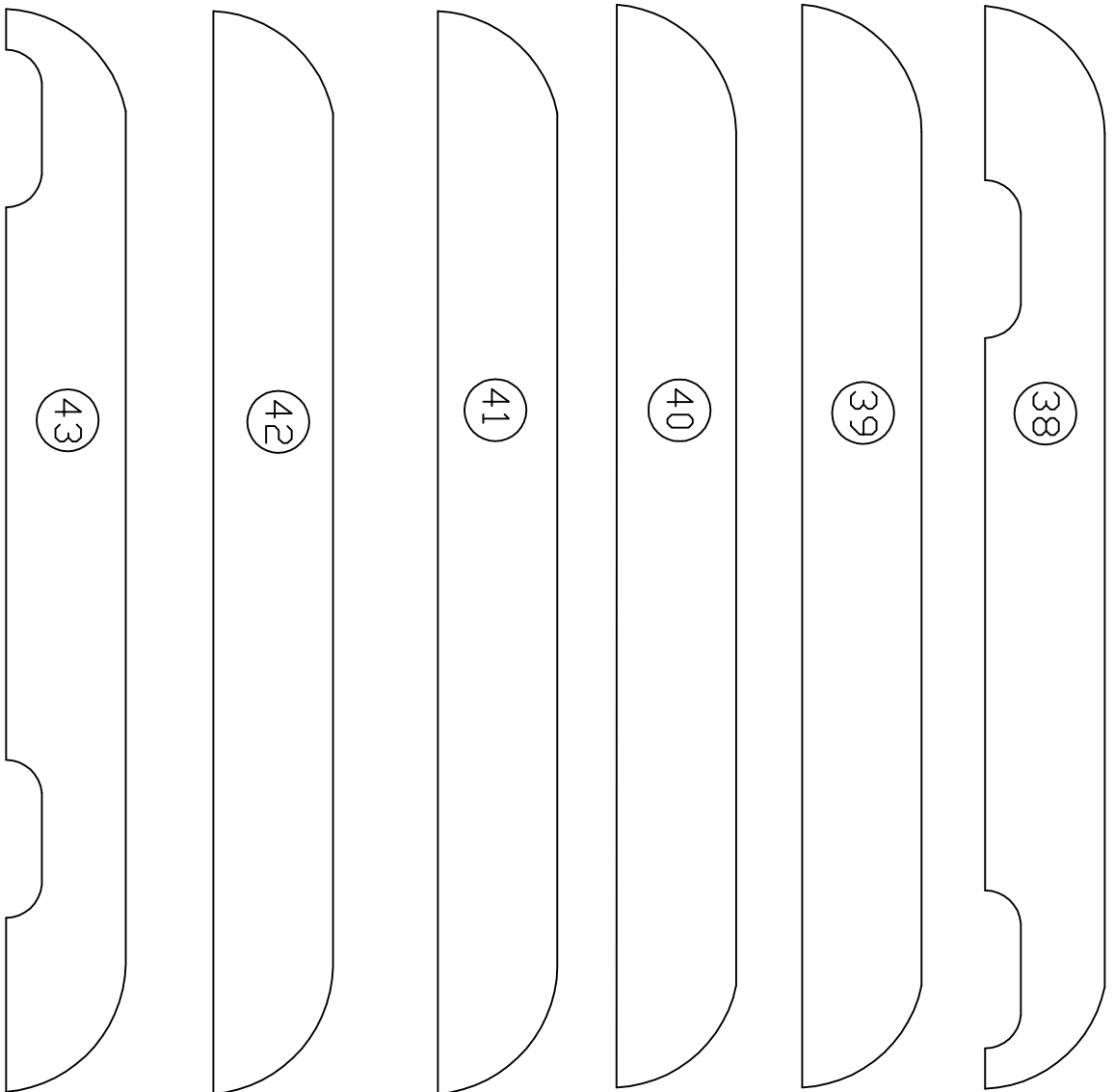



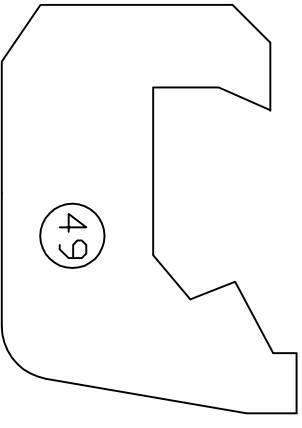
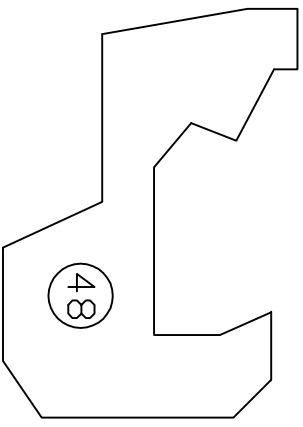
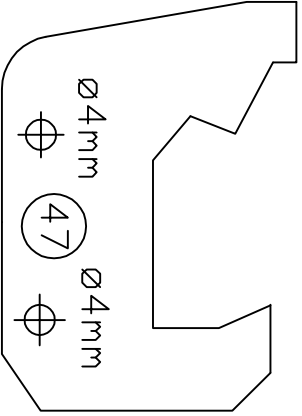
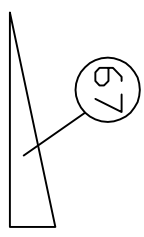
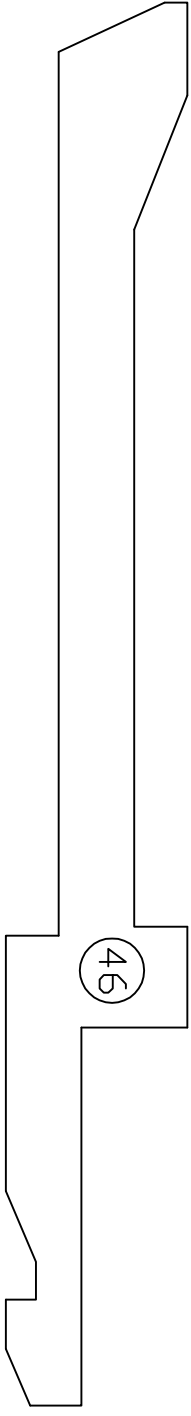
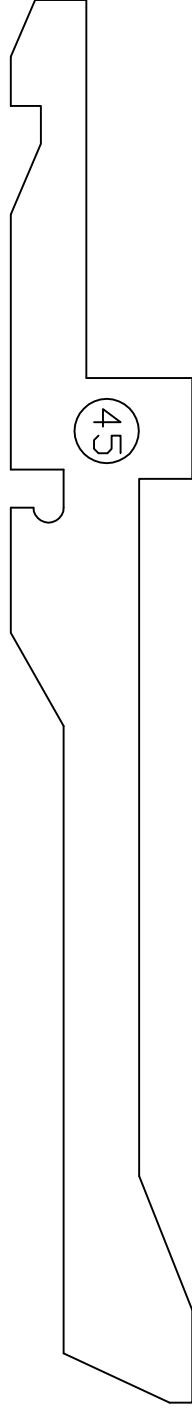
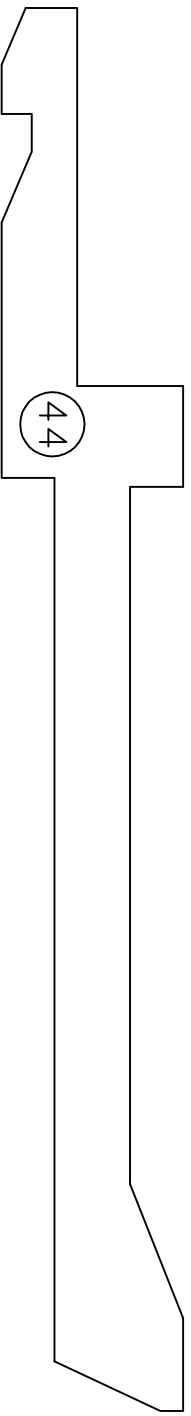

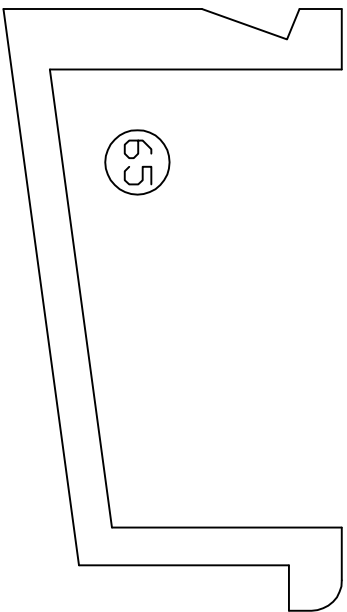
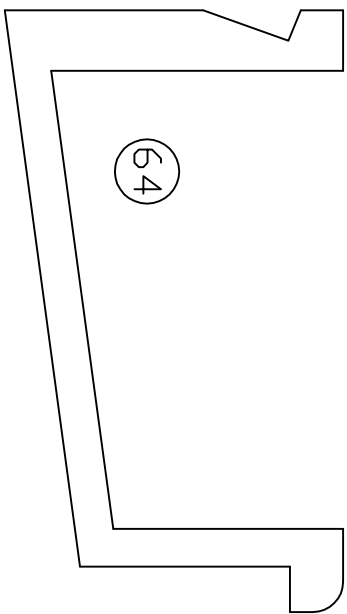
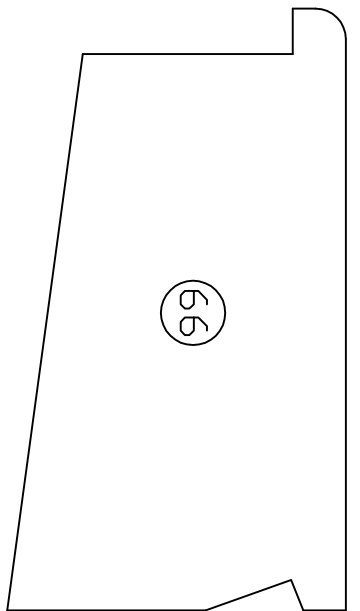
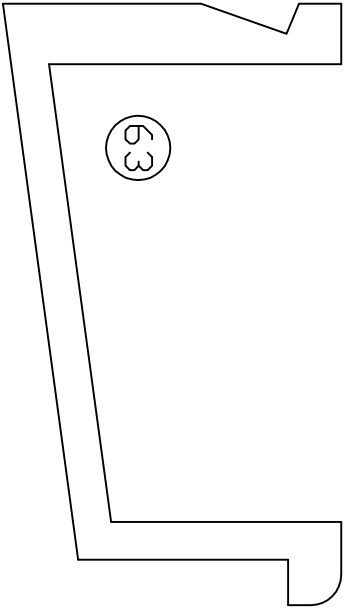
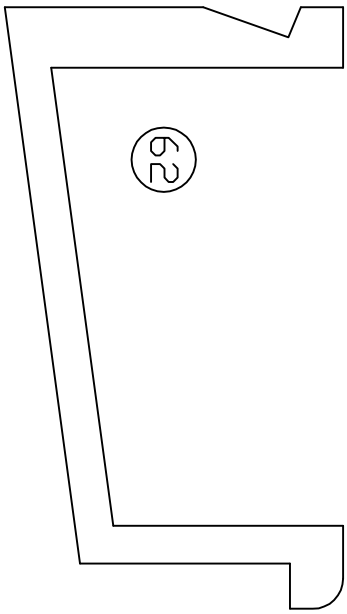
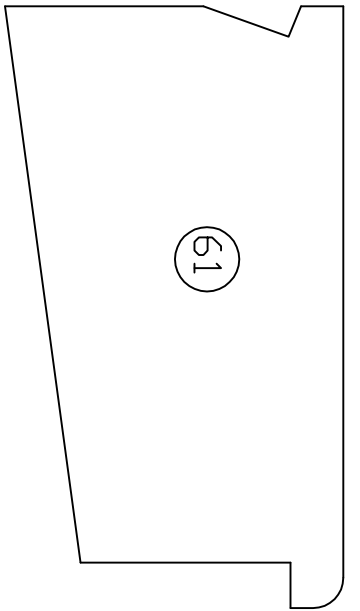
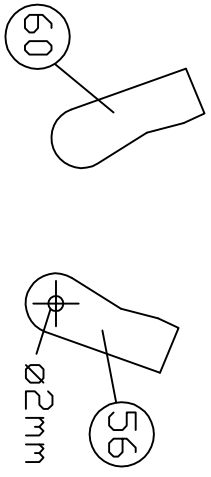
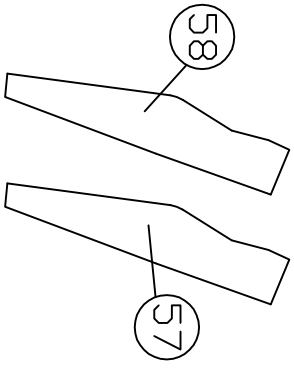
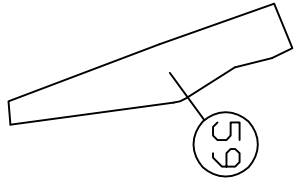

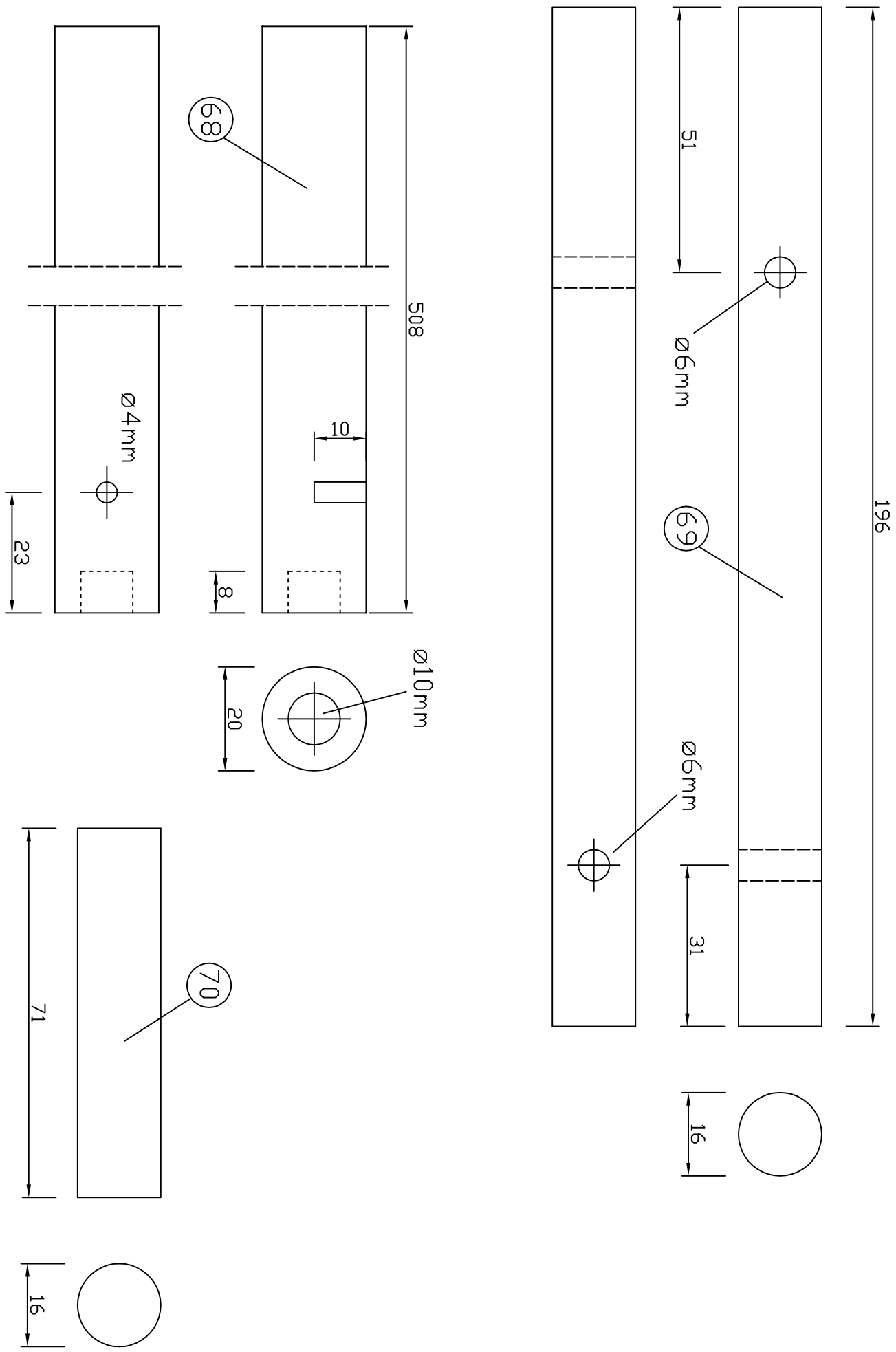

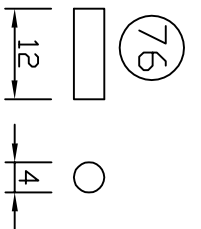
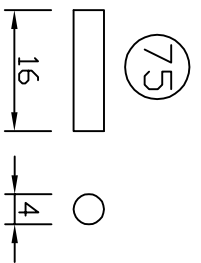
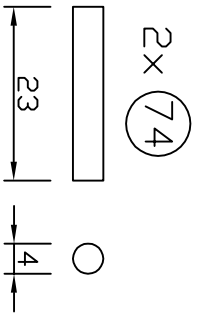
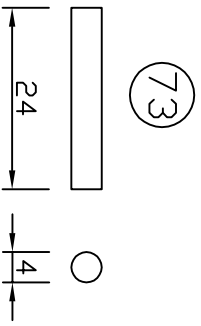
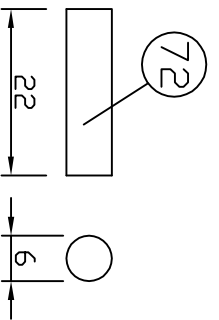
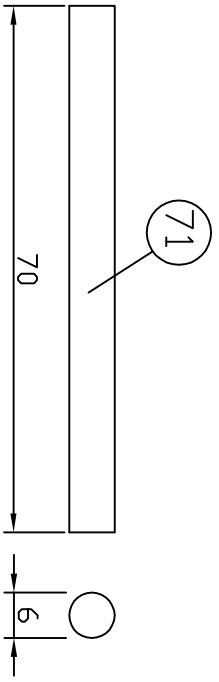

ø25 wooden ball

