

AK47 rubber band gun

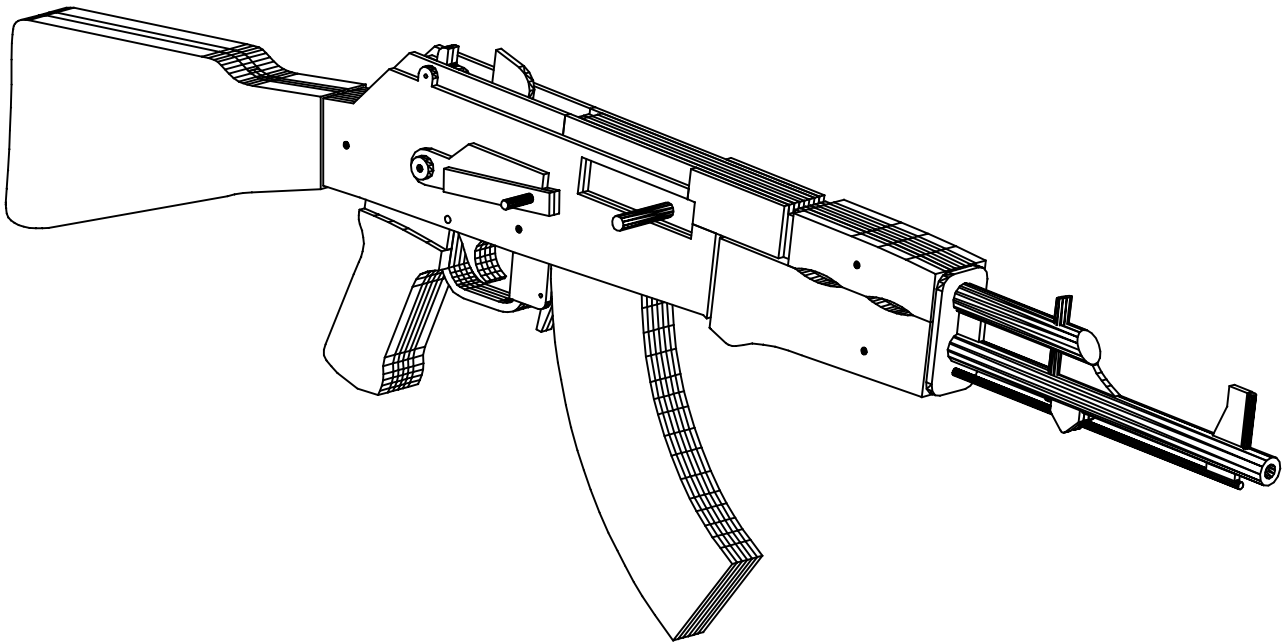

IMPORTANT!

This is a construction manual for making an harmless rubber band gun. You will make and use it on your own risk. If you don't agree, don't make this rubber band gun.

Please pay attention to laws concerning realistic imitation firearms in your country.

Materials:

- 4mm plywood ca. 1200x900mm
- 8mm hardwood ca. 600x140mm
- 14mm hardwood ca. 500x130mm

- 2x ø2mm nail (steel)

- ø16mm hardwood dowel 263mm
- ø16mm hardwood dowel 142mm
- ø8mm hardwood dowel ca. 150mm
- ø5mm hardwood dowel 50mm
- ø4mm hardwood dowel ca. 450mm

- 2x screw 3,5x16mm (countersunk)
- 1x screw 3x12mm (countersunk)
- 2x screw 3x20mm (countersunk)
- 2x screw 3x25mm (countersunk)

- 1x spring ø4mm

- rubber bands ø40mm (US size #16)
- rubber bands ø100mm (US size #116)

Tools:

- scroll saw (fret saw)
- drill press (cordless drill)
- sandpaper
- wood glue
- clamps
- screwdriver
- ø2, ø3, ø4, ø5, ø8, ø10mm brad point drill

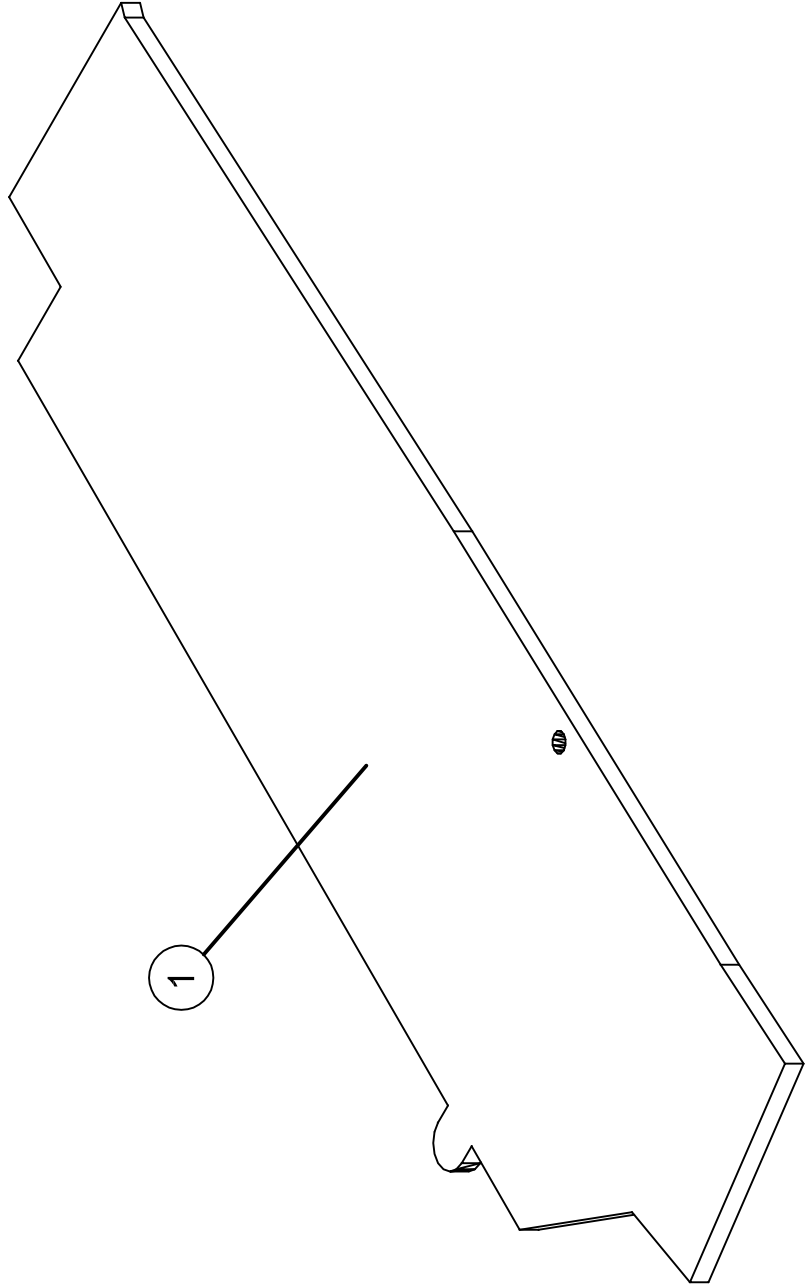

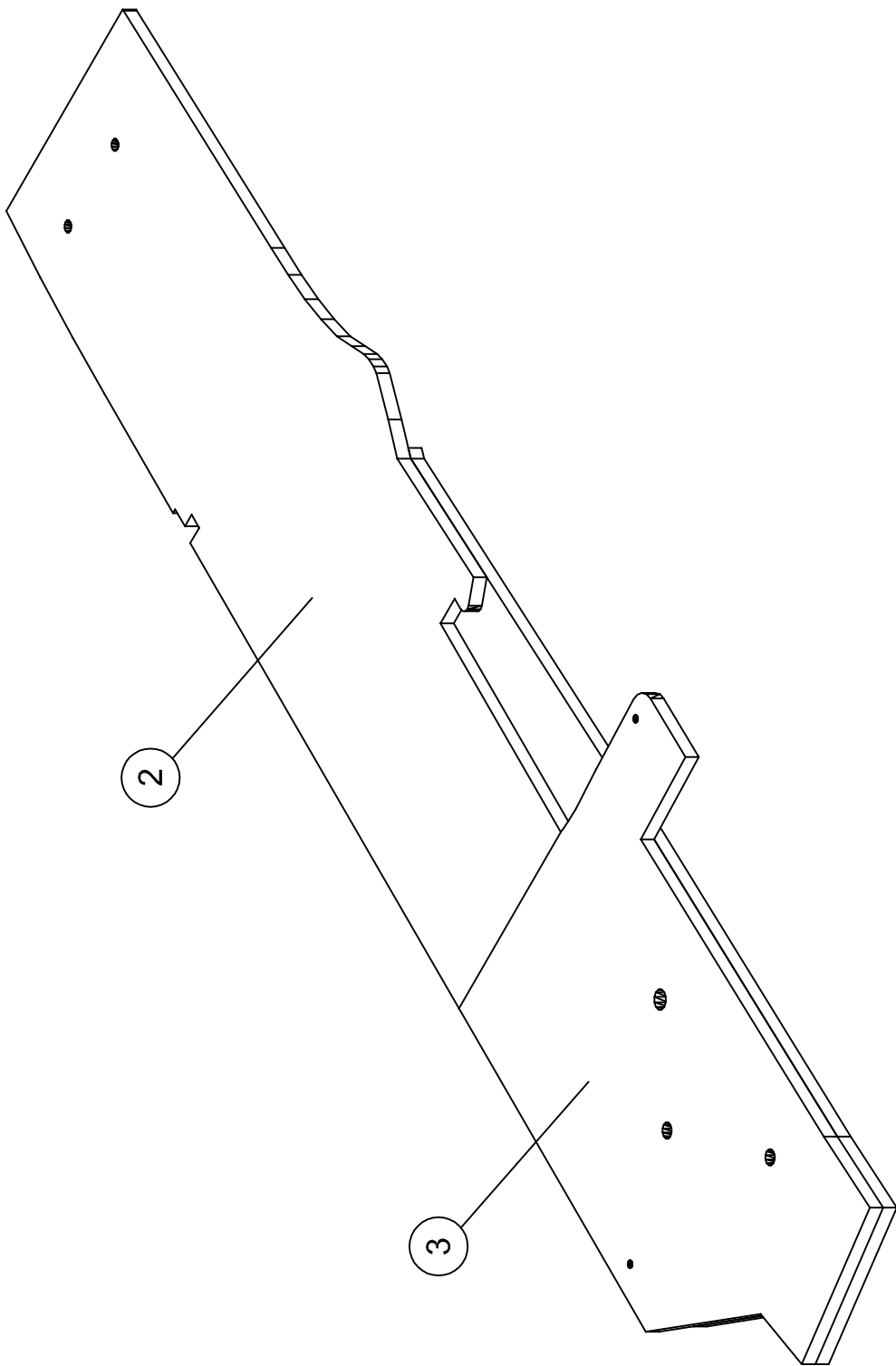

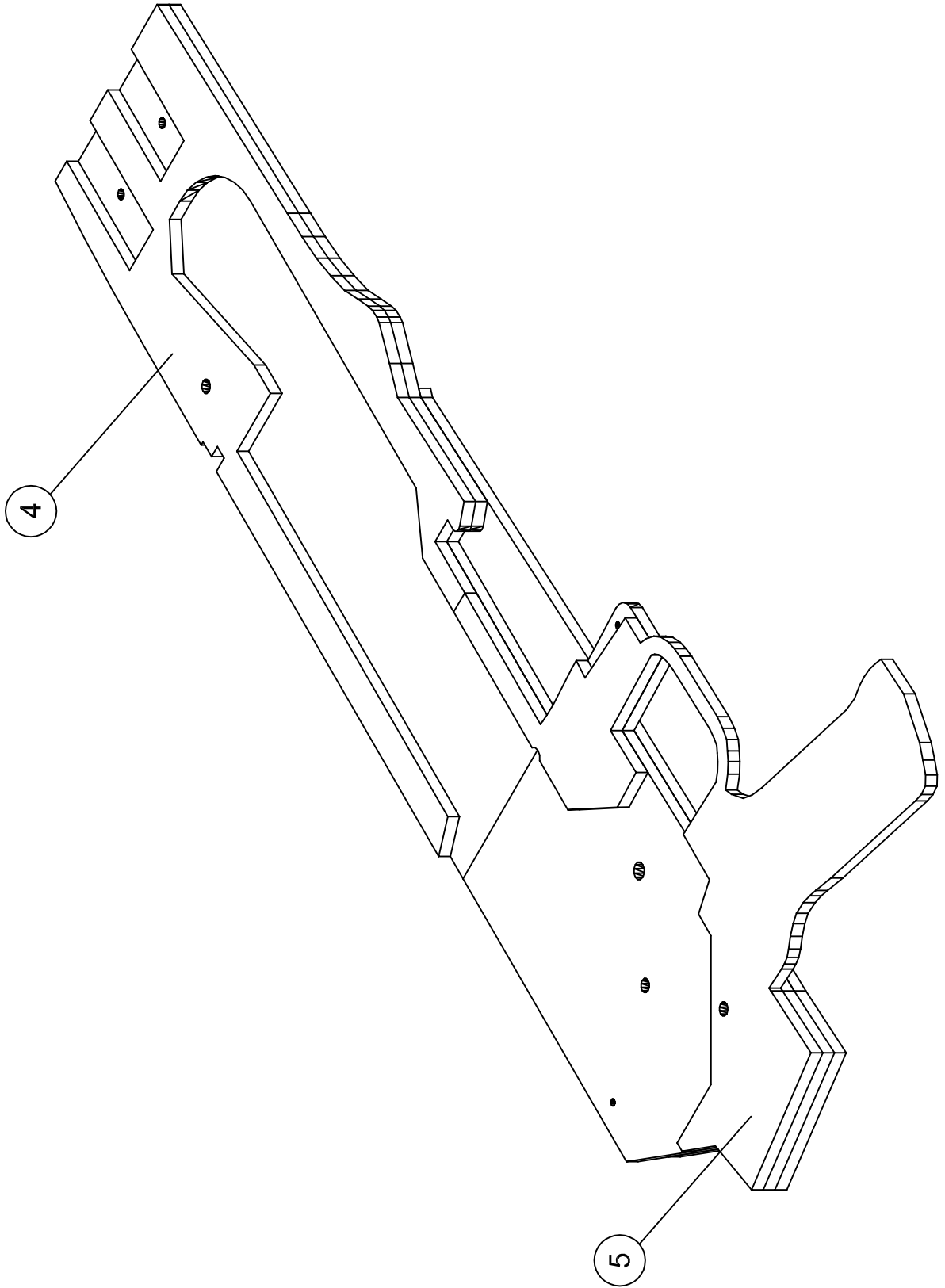

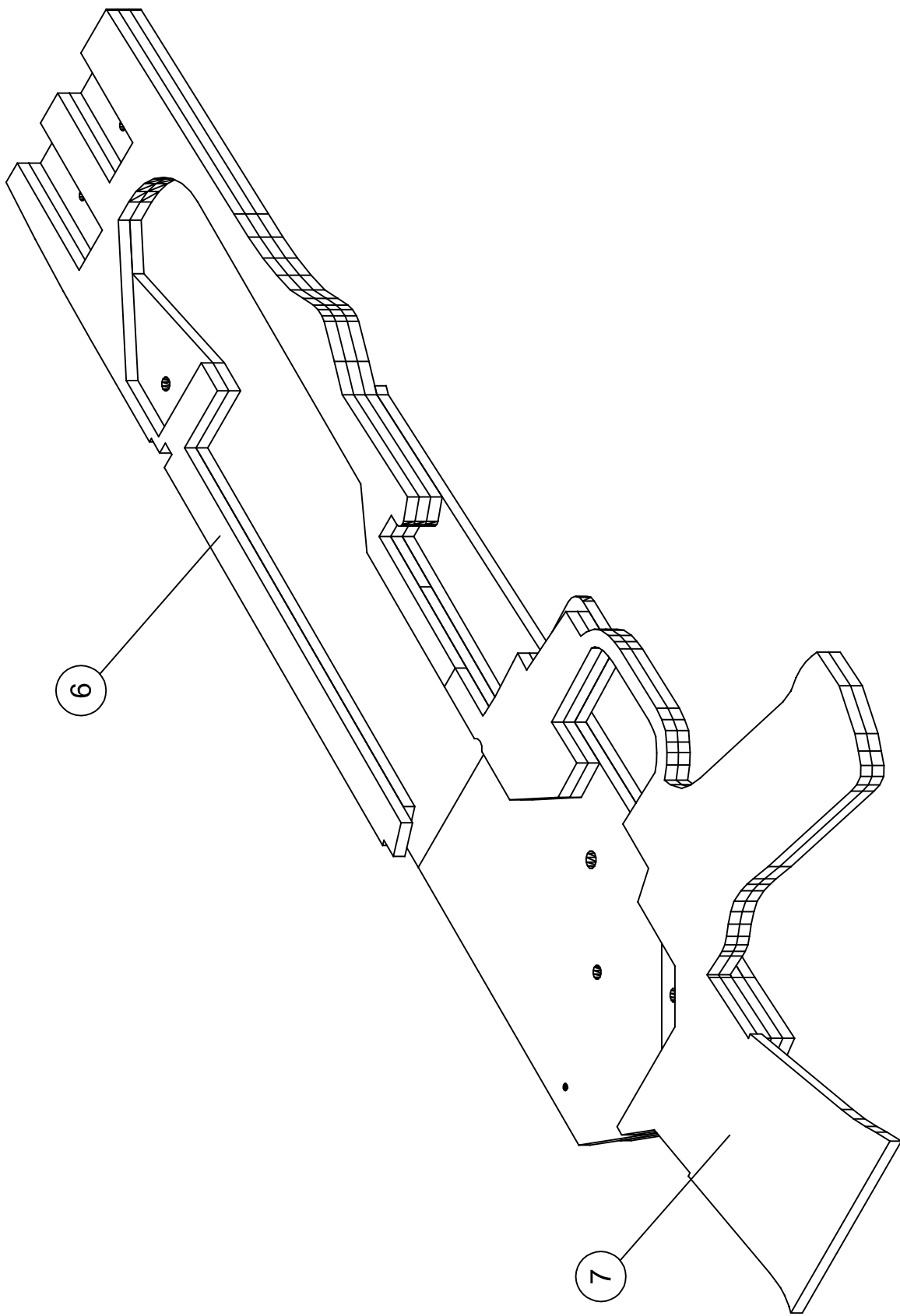

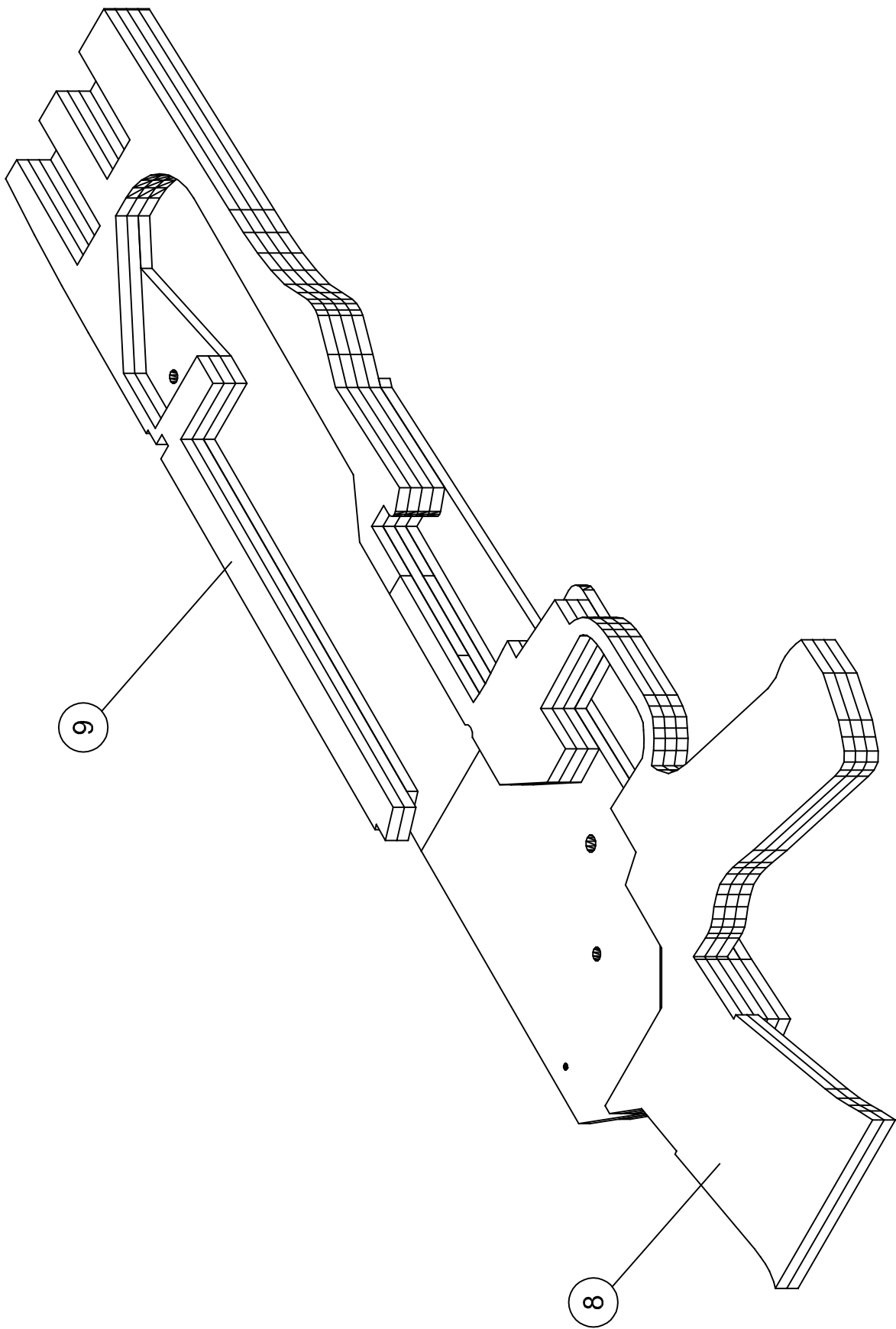

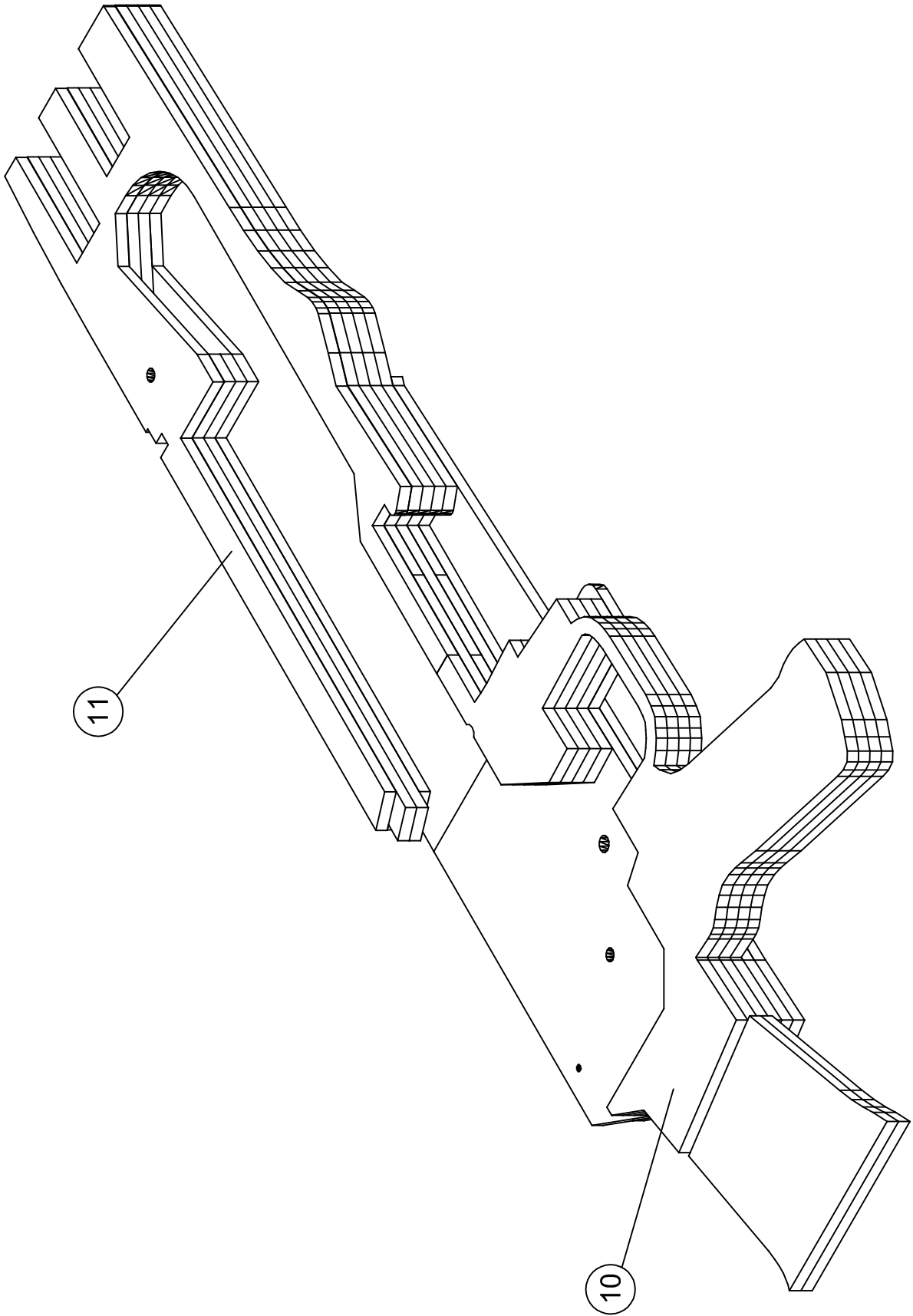

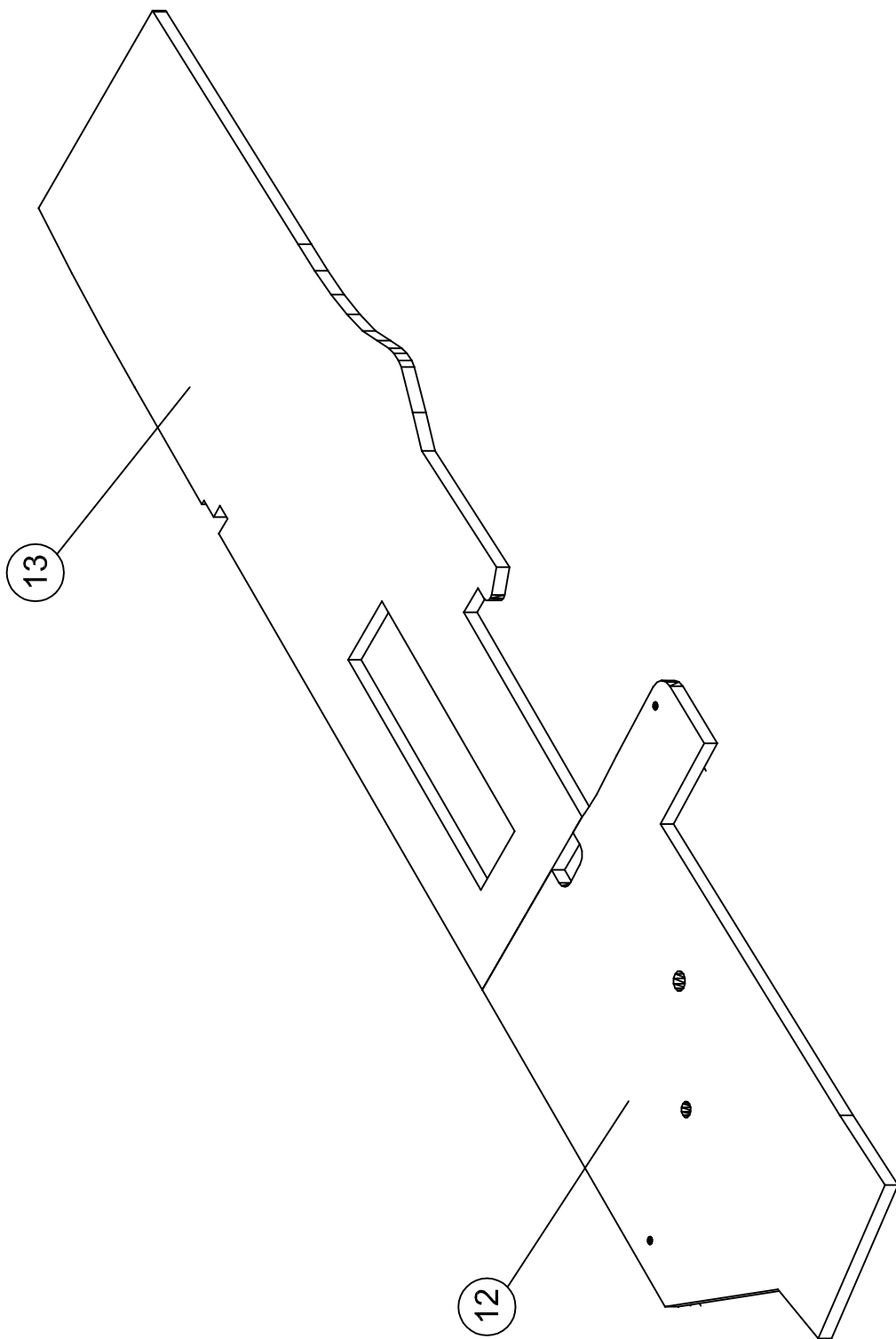

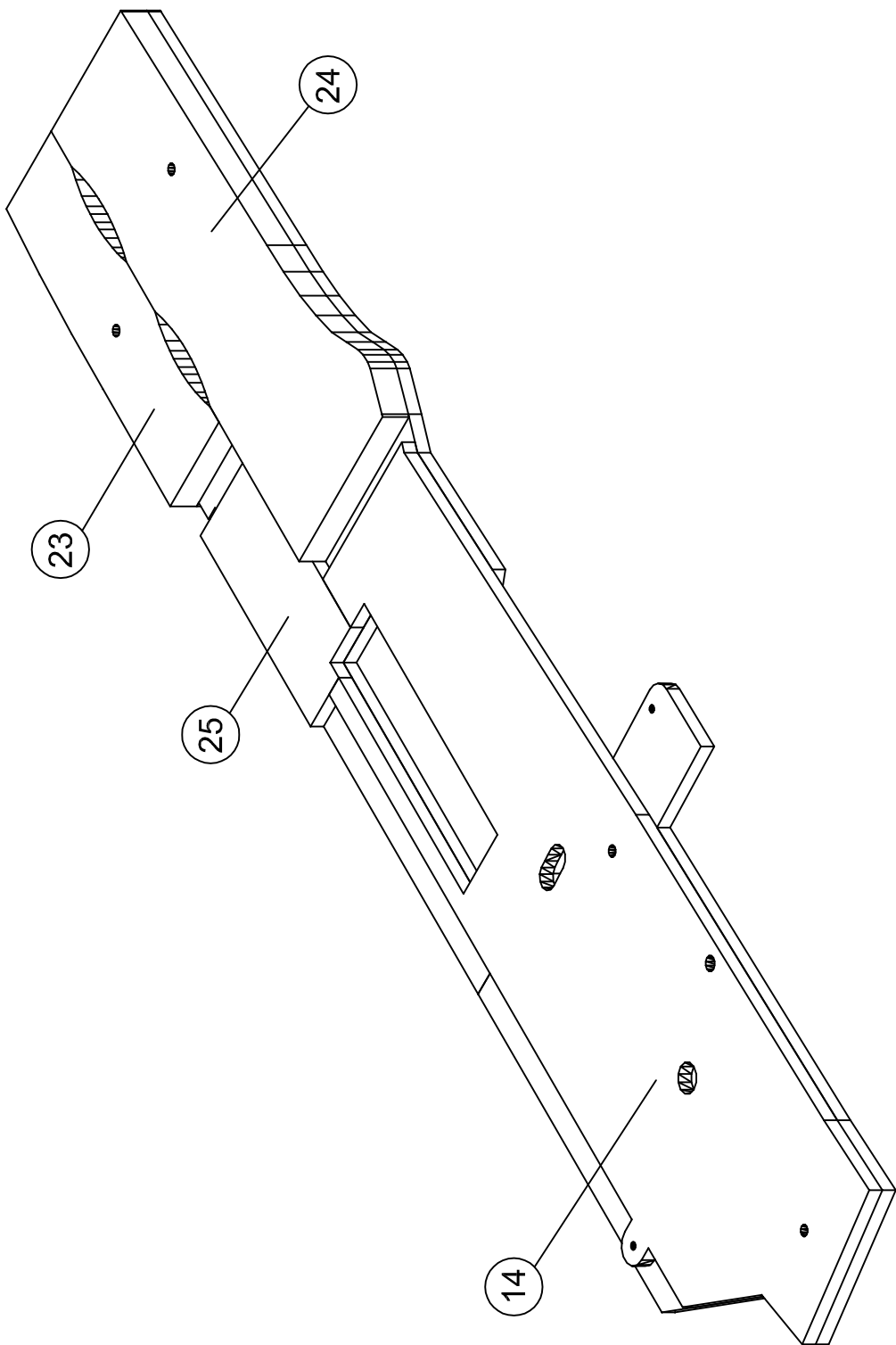

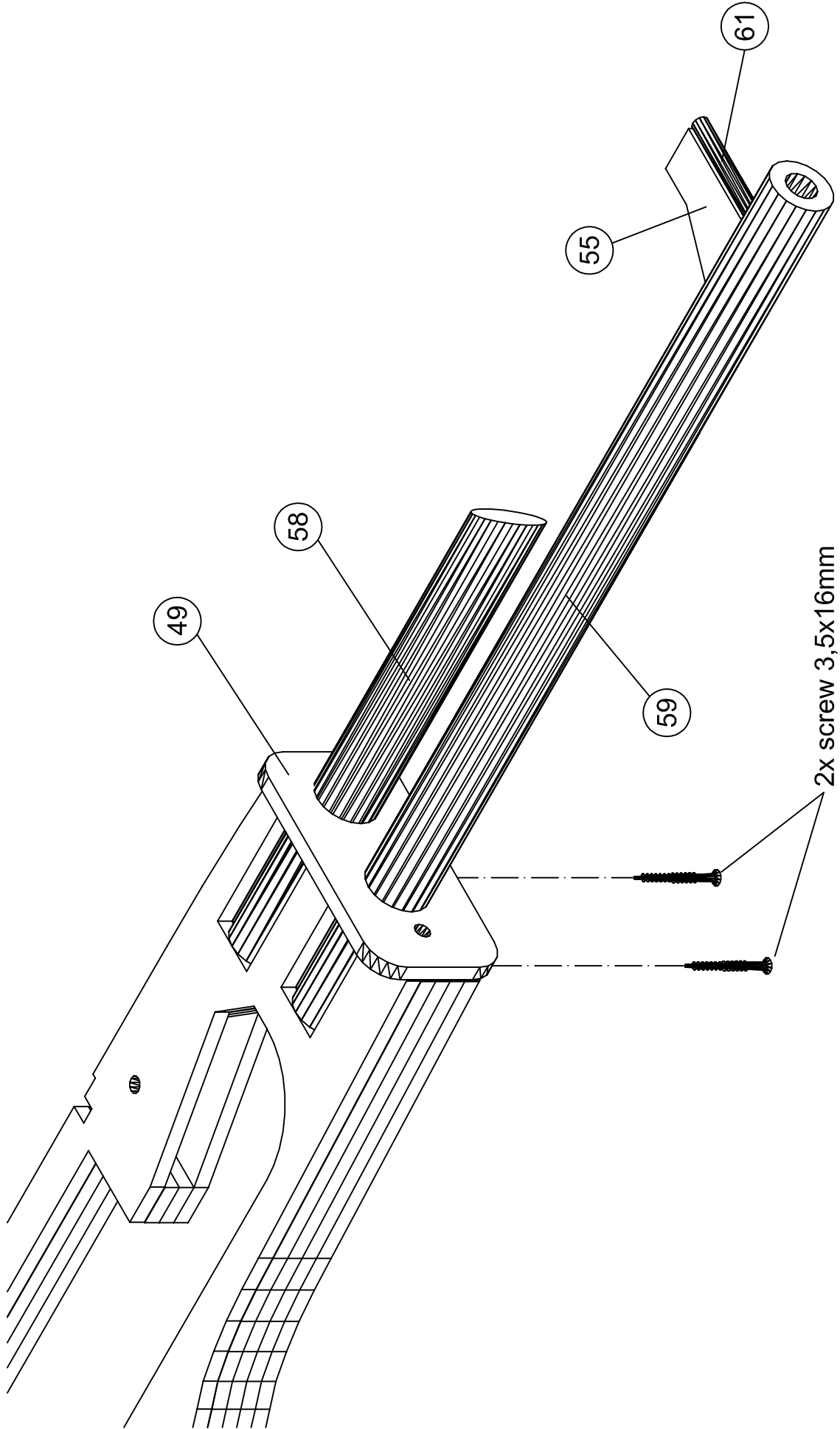

2x screw 3,5x16mm

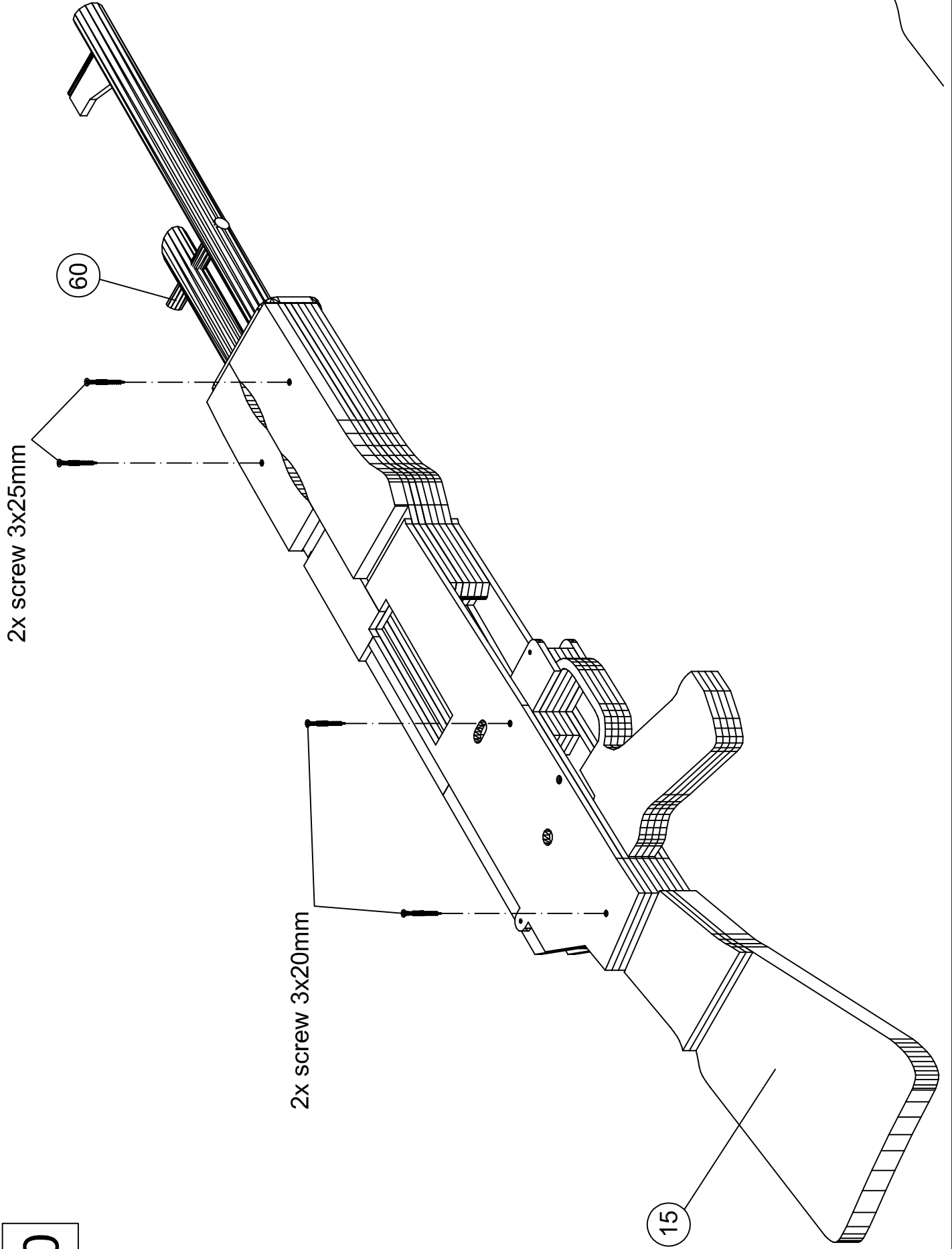

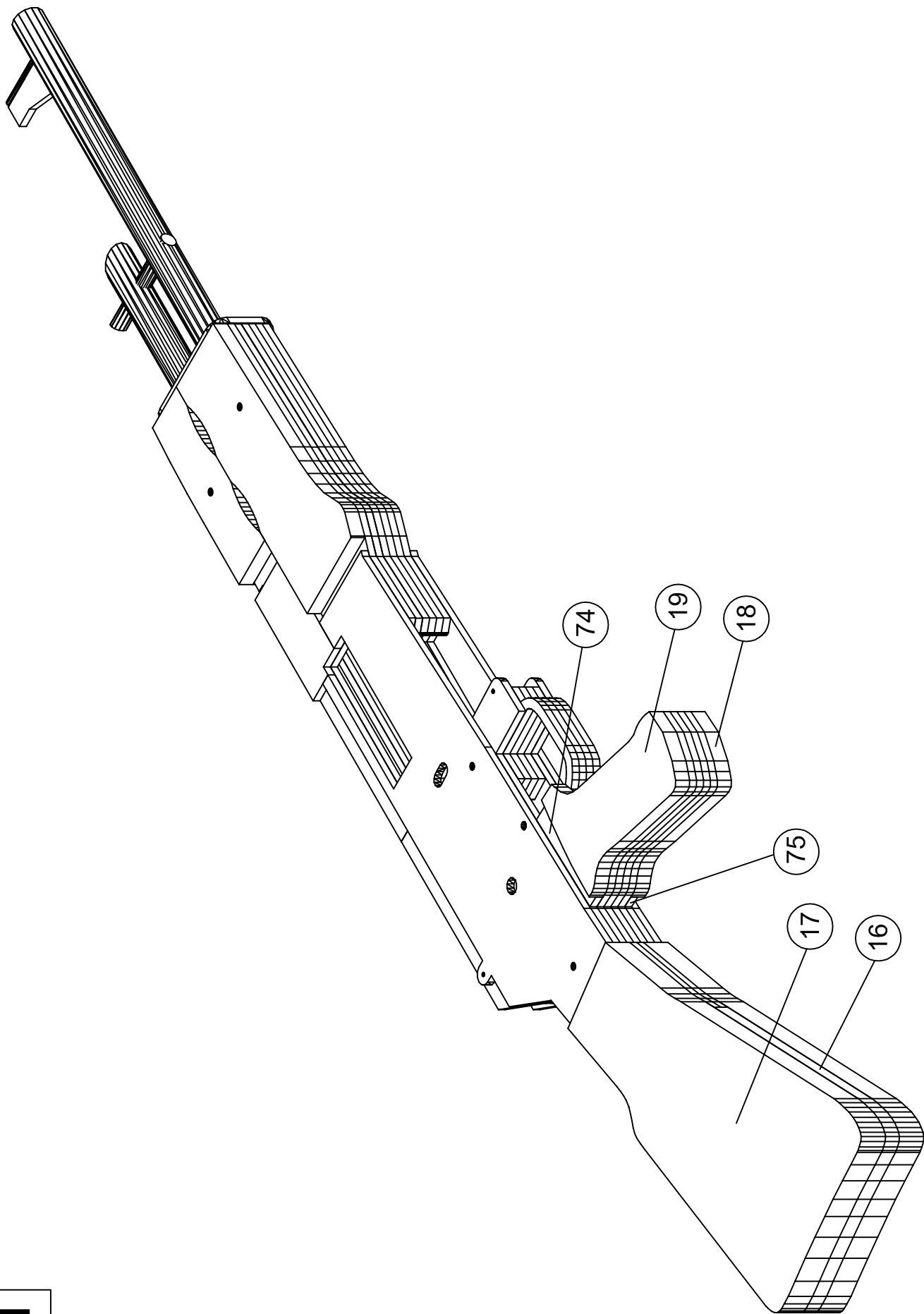

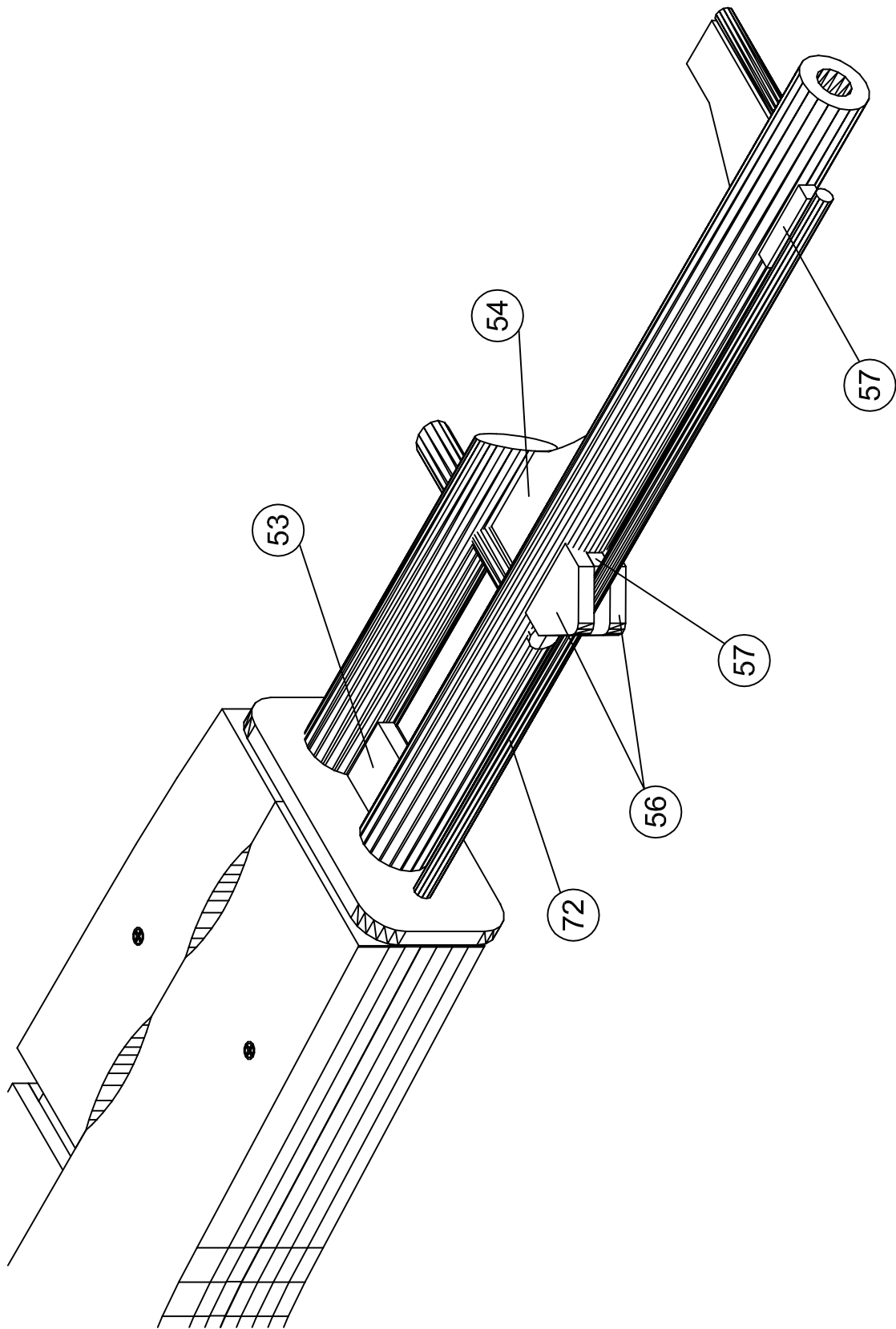

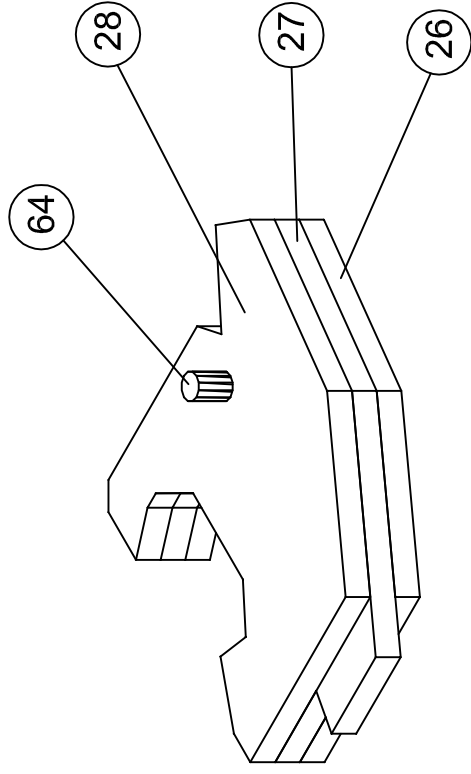

14

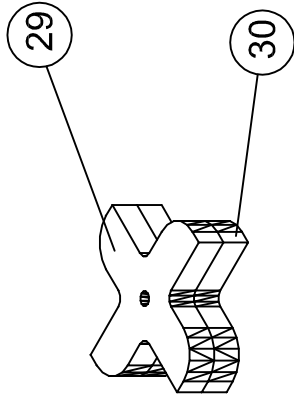

13

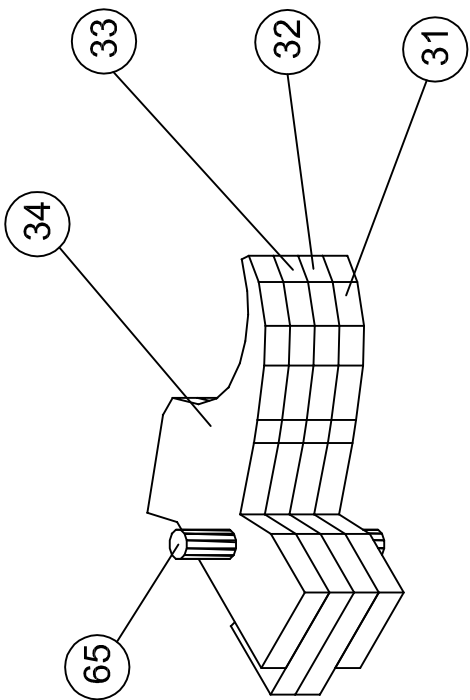

16

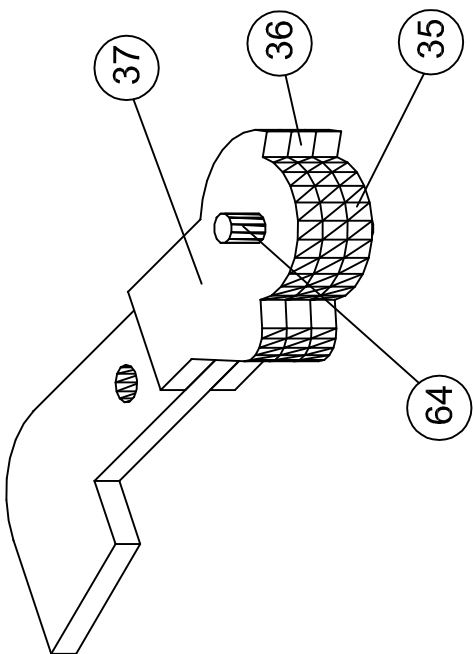

15

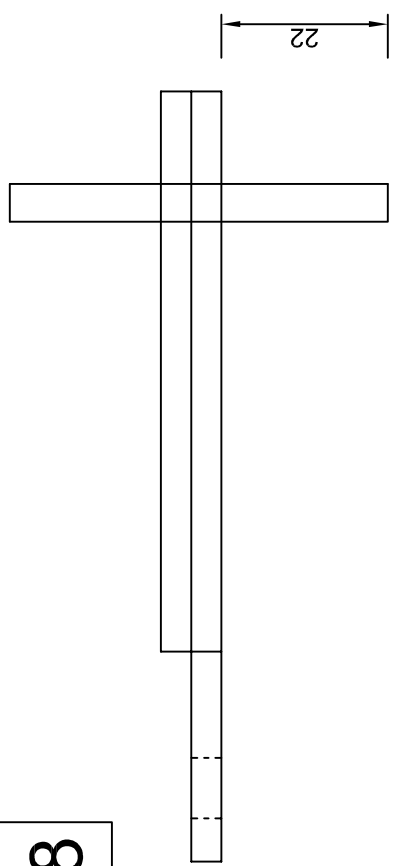
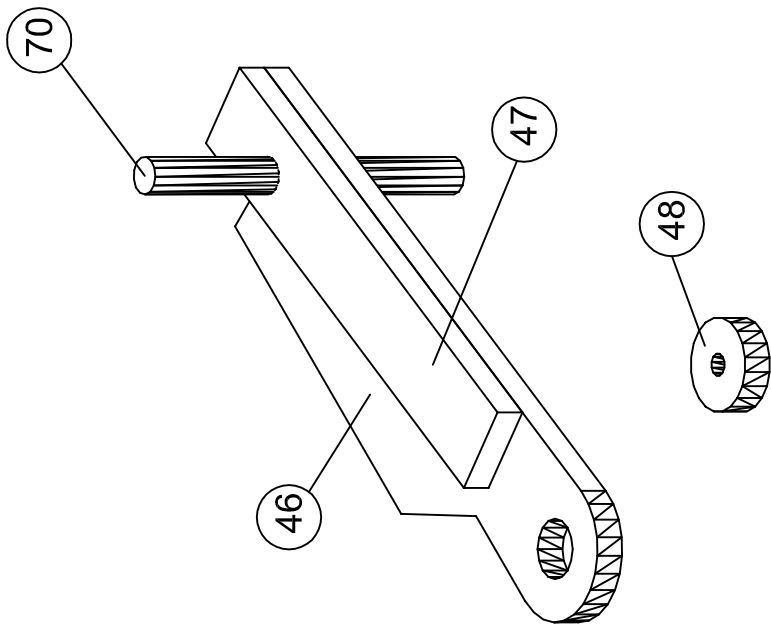

18

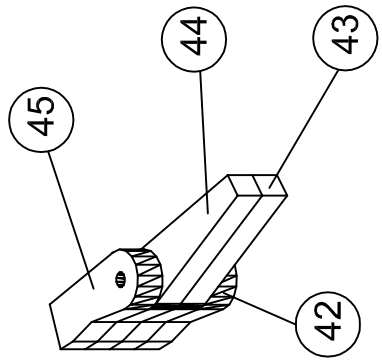

17

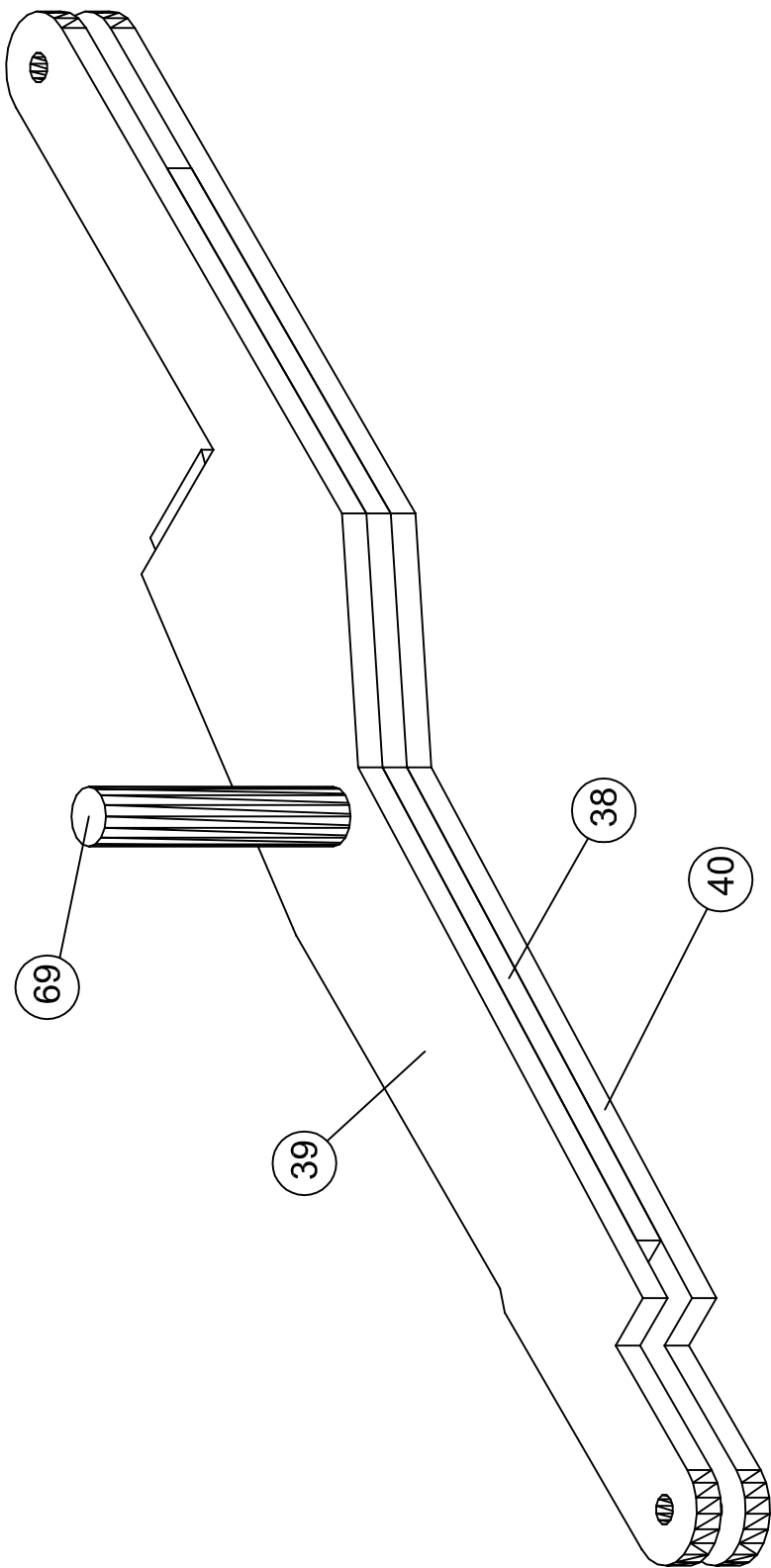

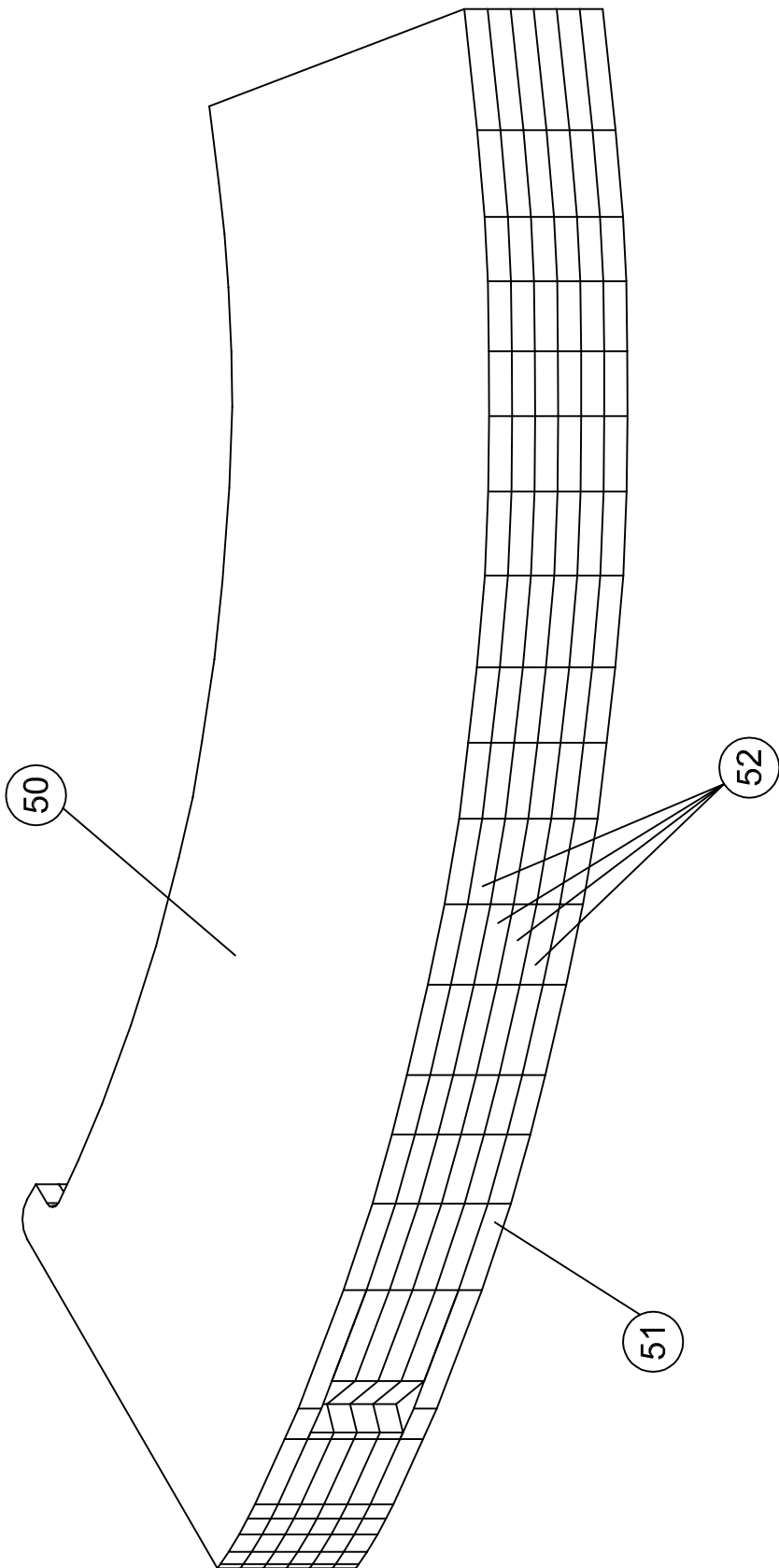

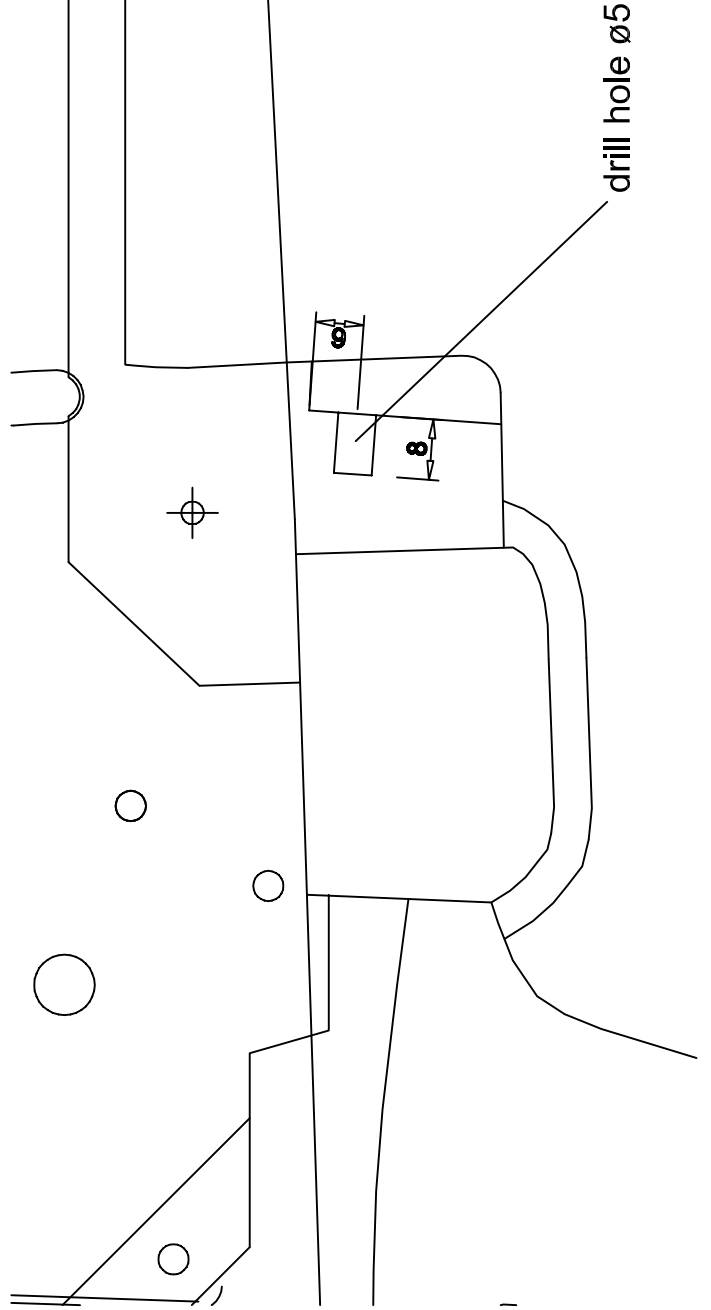
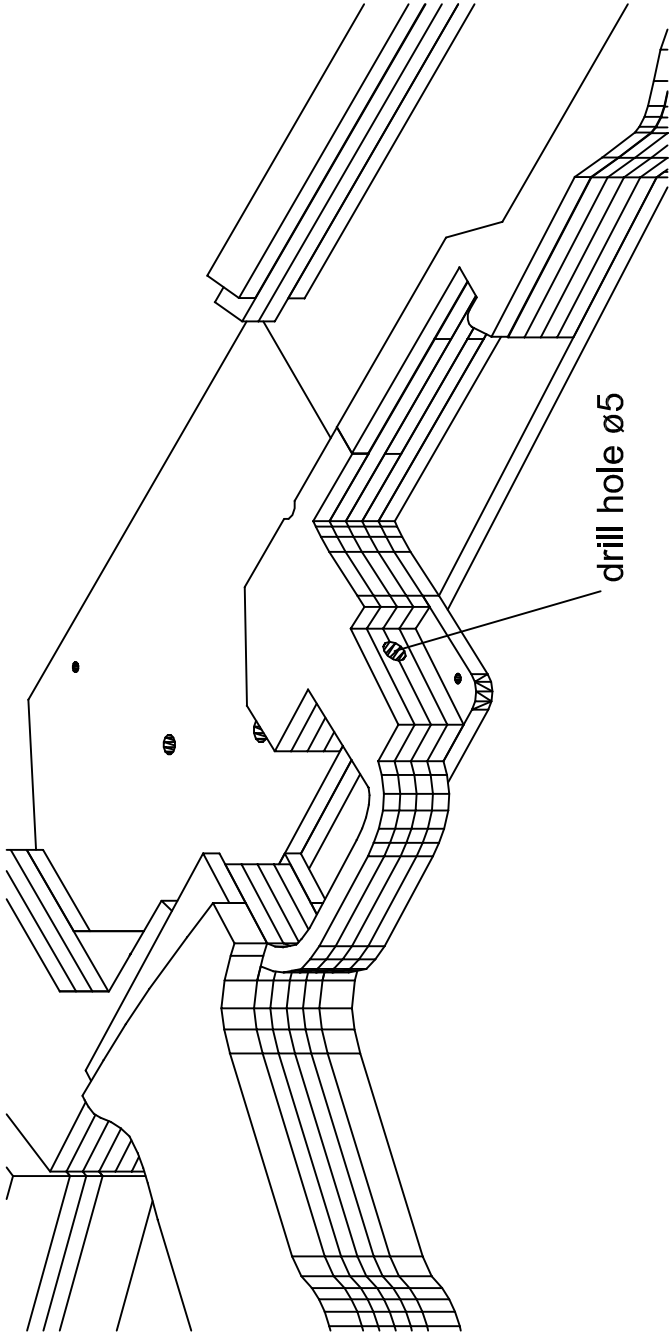

22

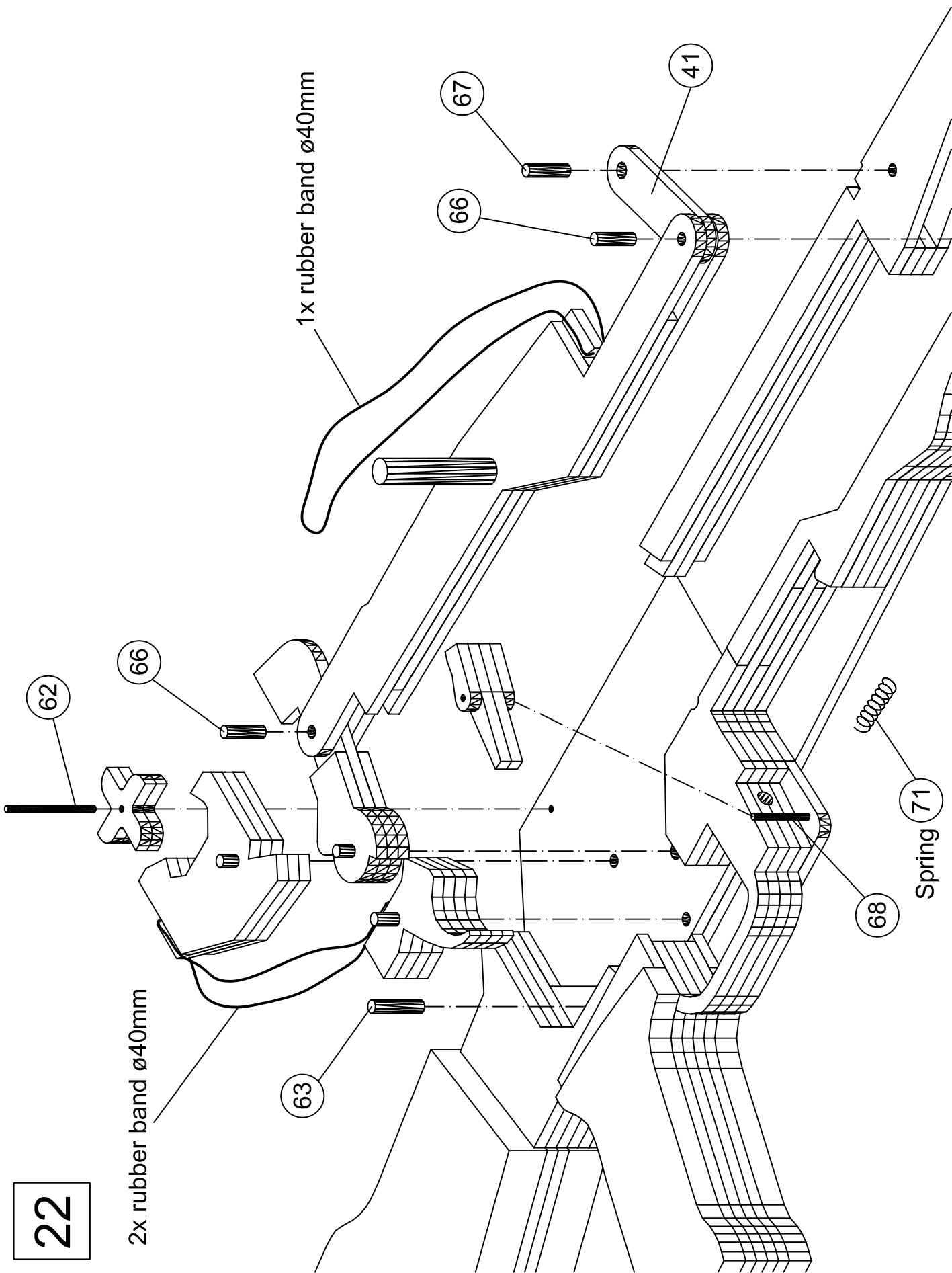

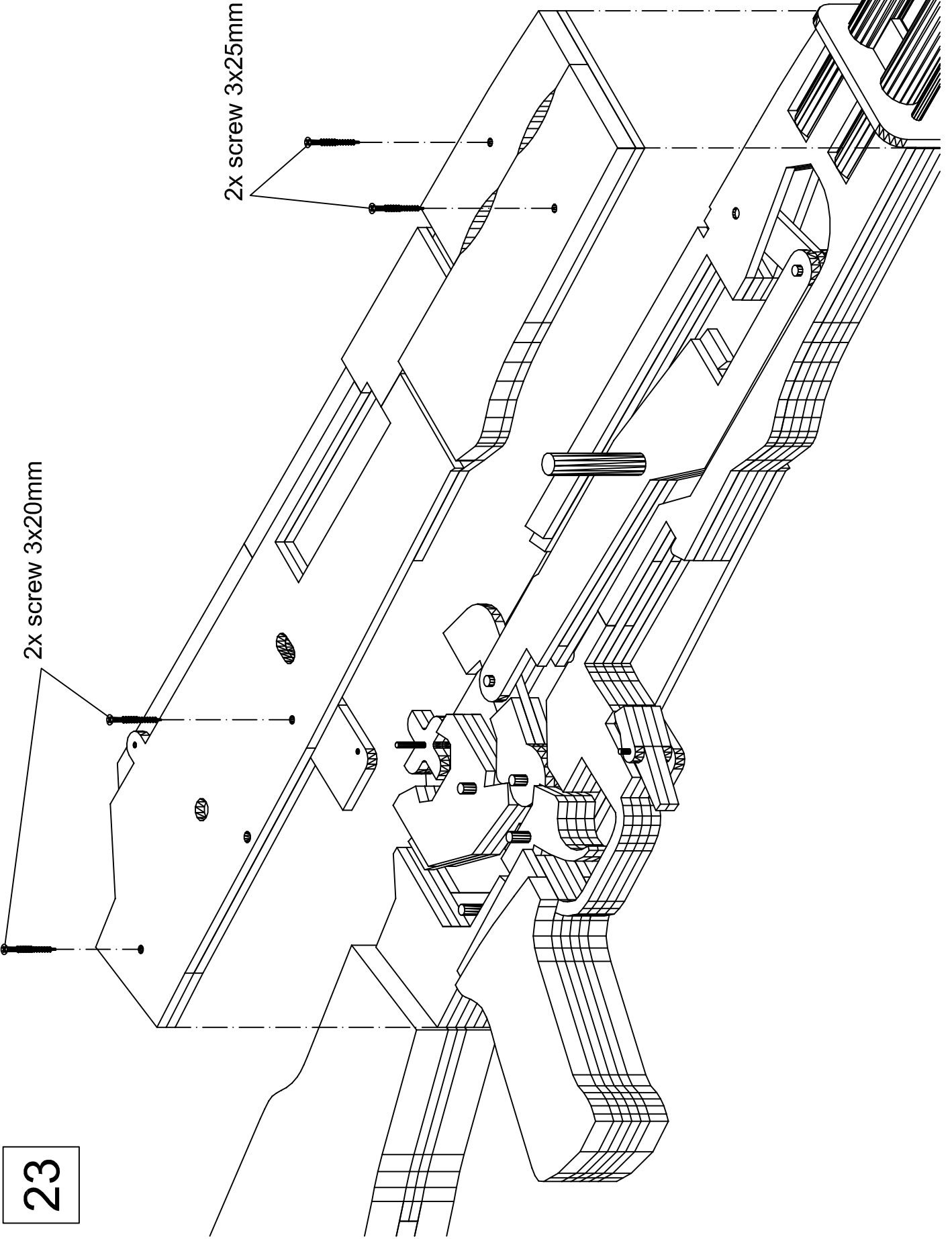

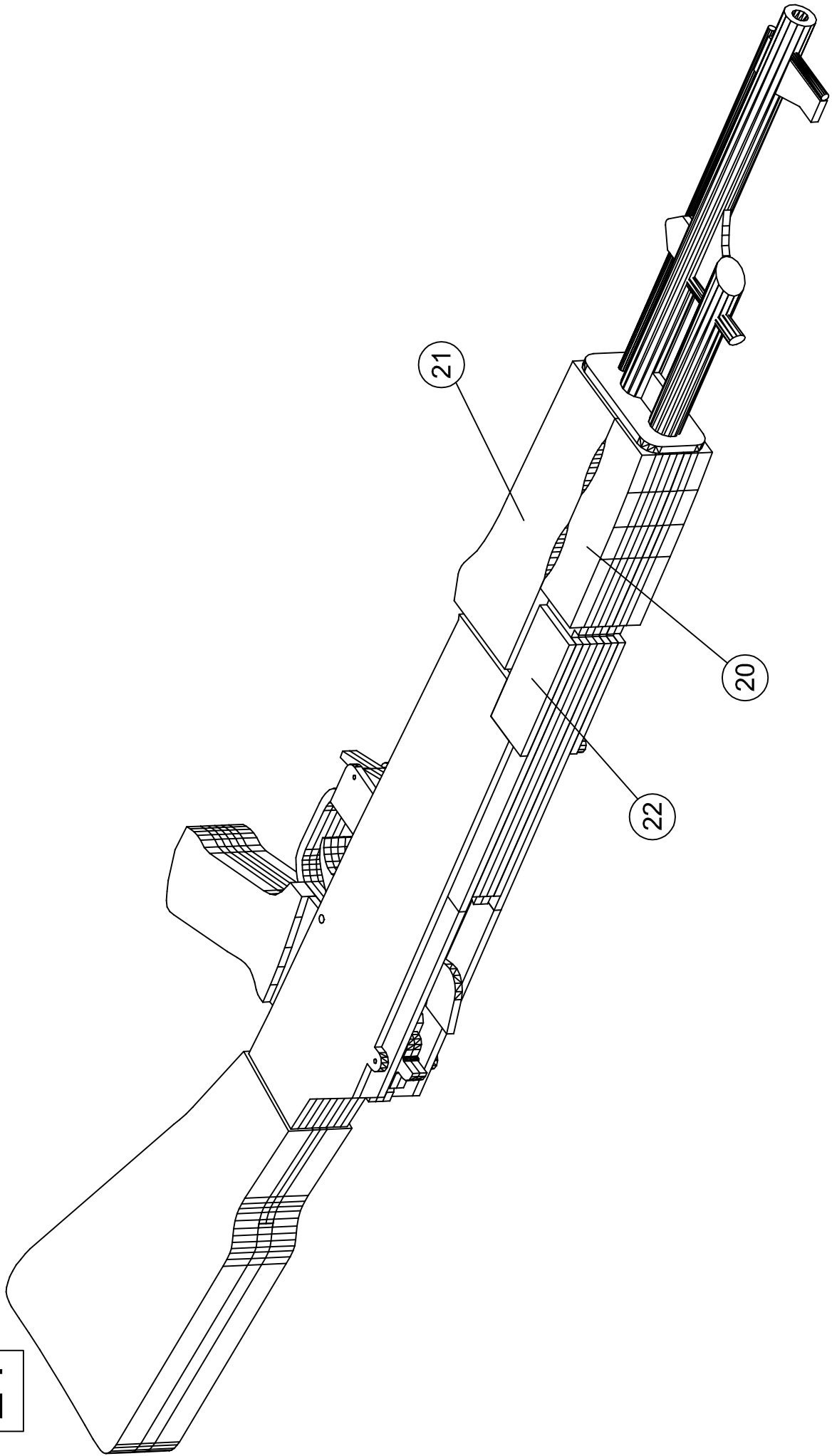

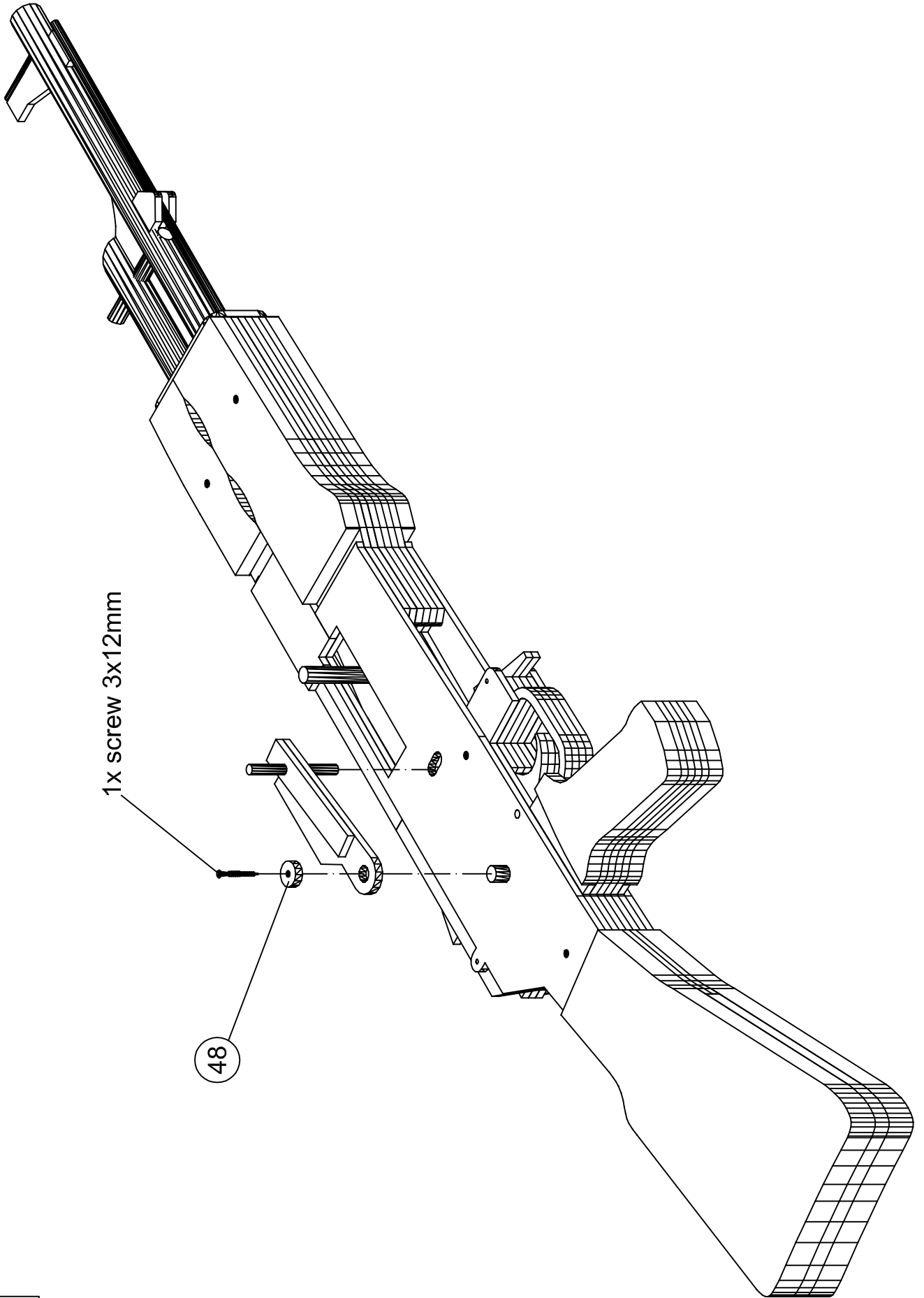

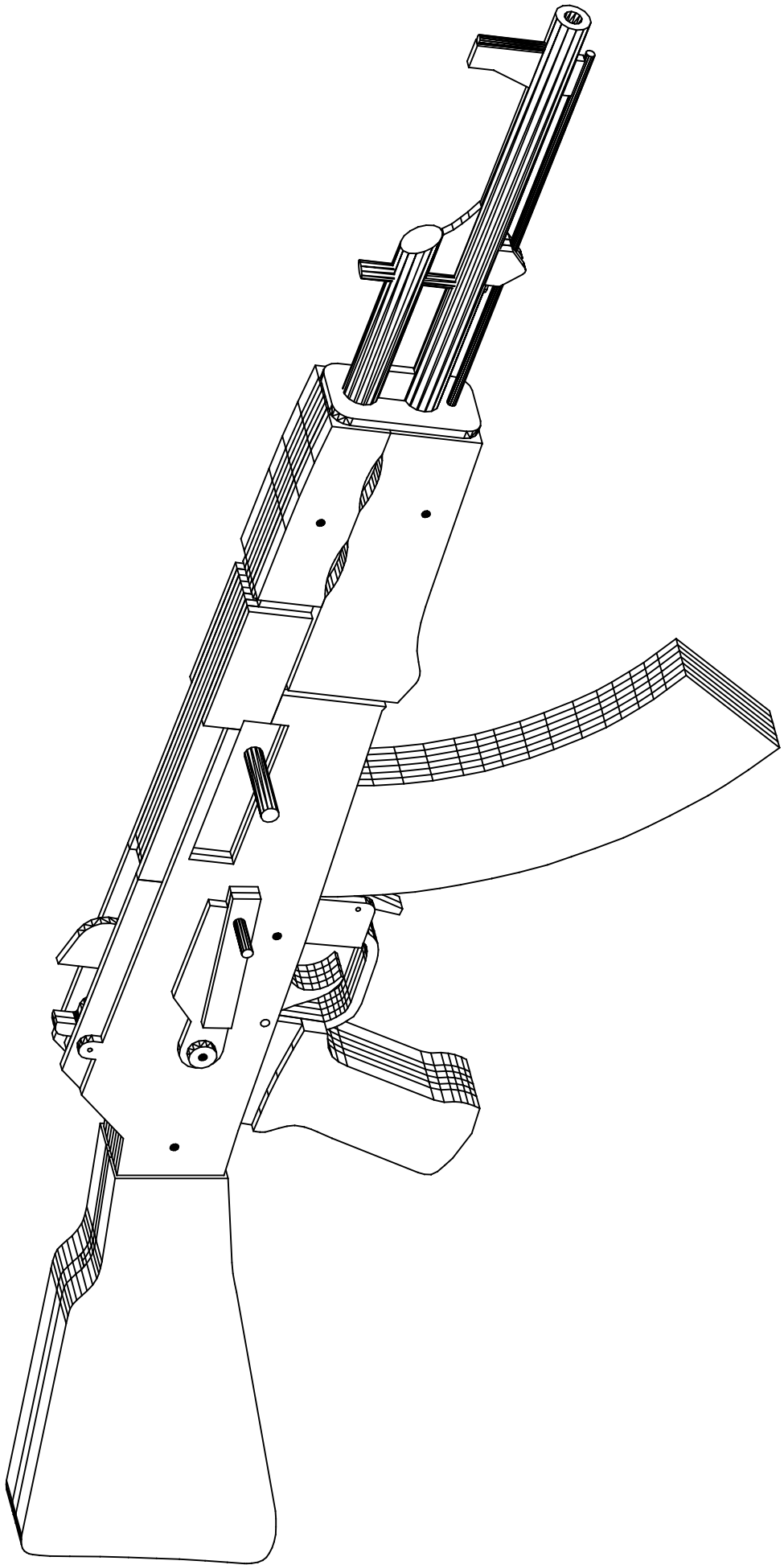

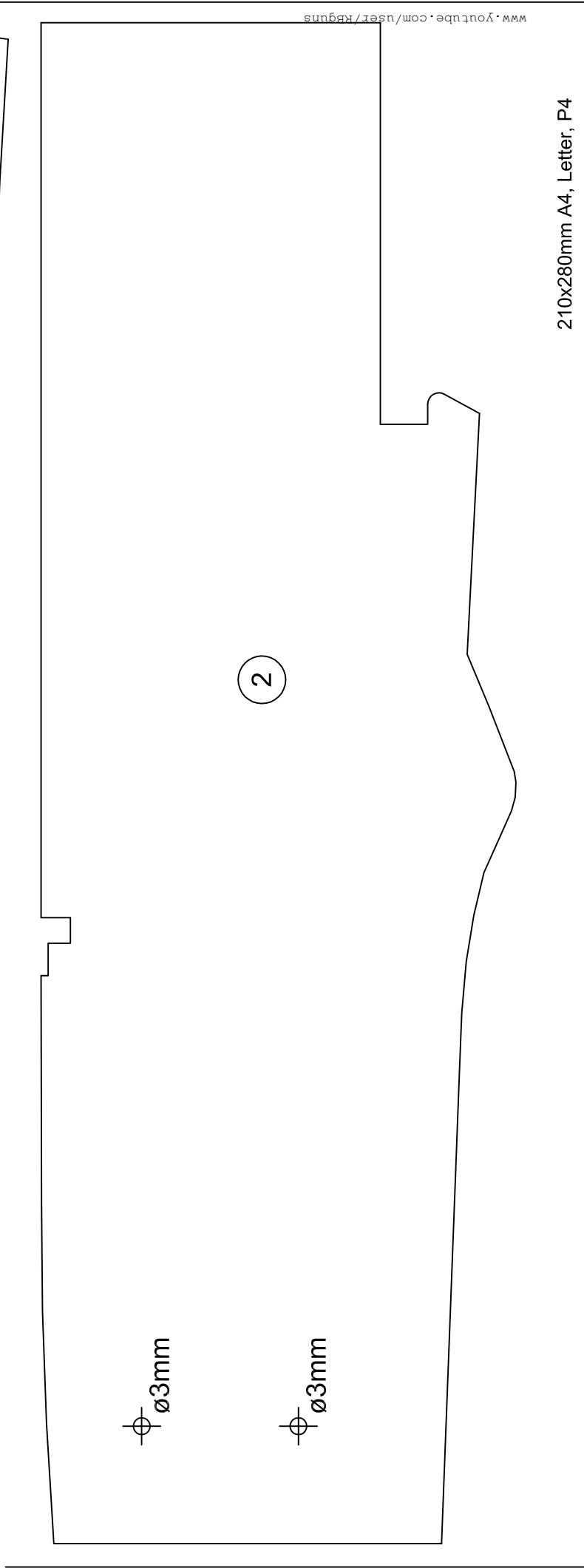
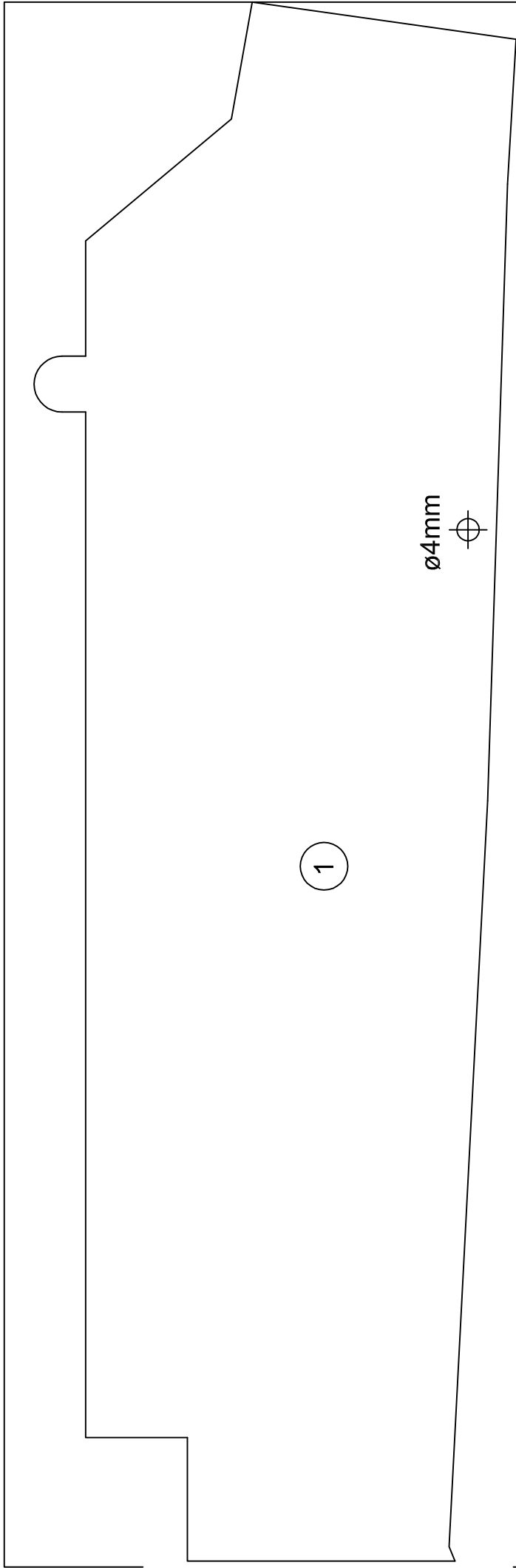

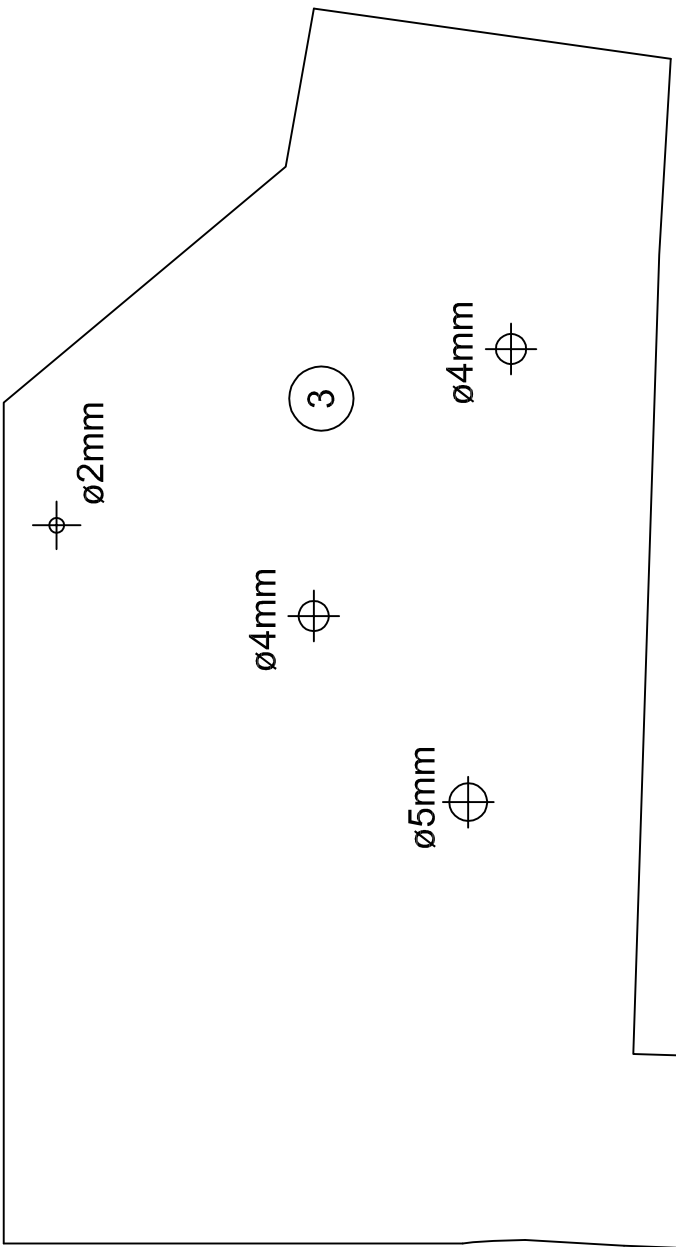

$\phi 2\text{mm}$

$\phi 4\text{mm}$

$\phi 5\text{mm}$

$\phi 4\text{mm}$

3

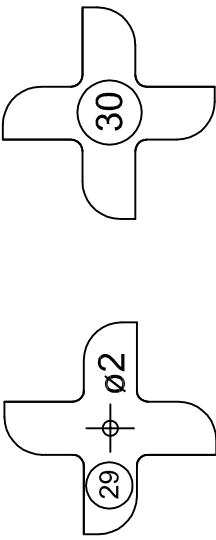

29

$\phi 2$

30

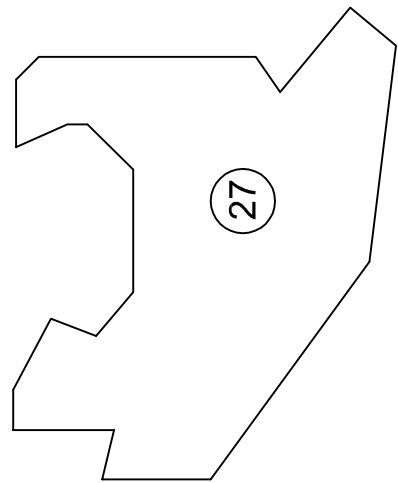

27

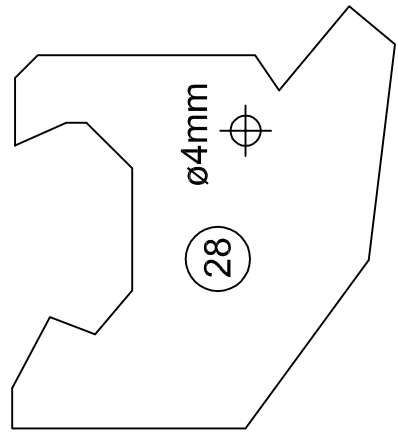

28

$\phi 4\text{mm}$

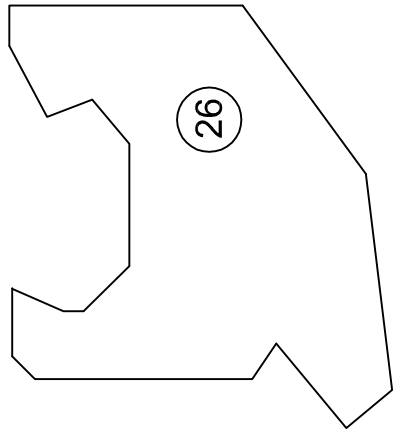

26

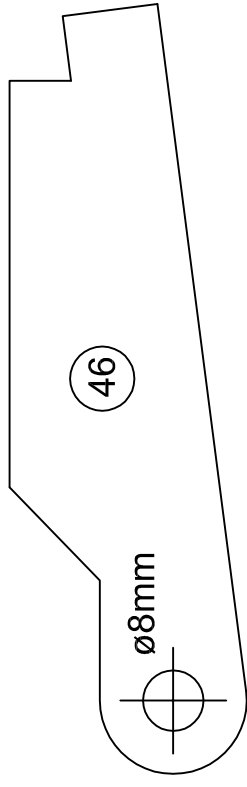

46

$\phi 8\text{mm}$

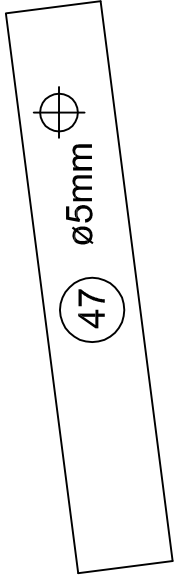

47

$\phi 5\text{mm}$

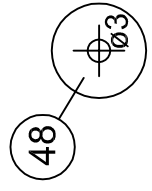

48

$\phi 3$

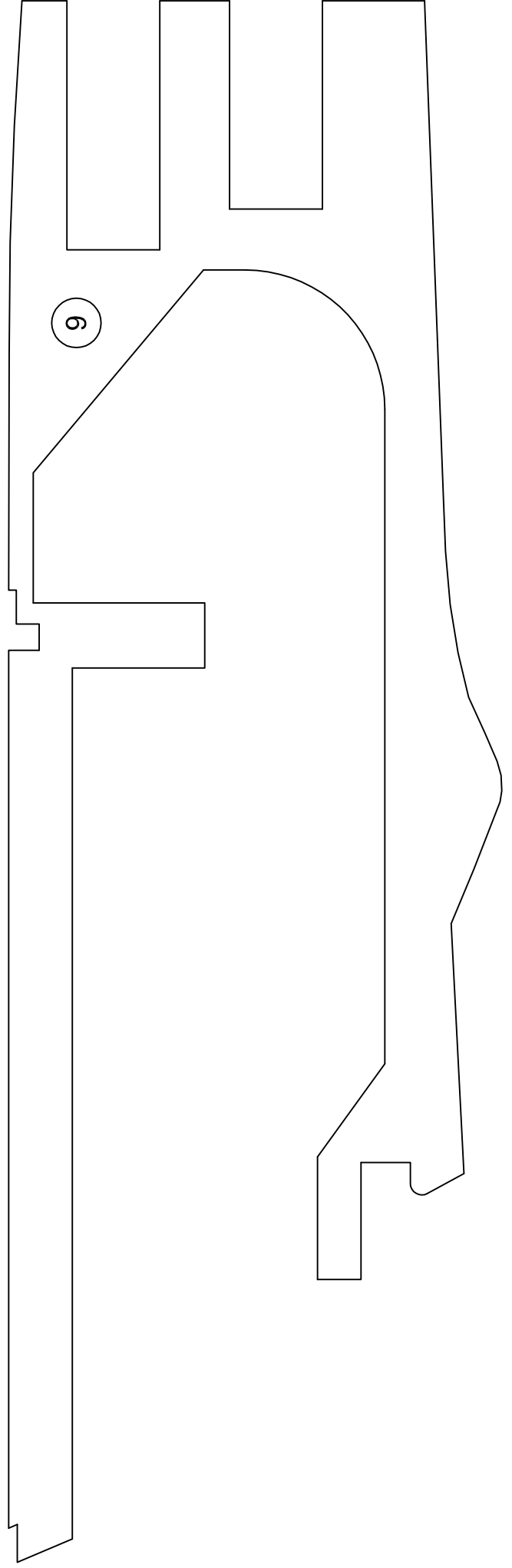
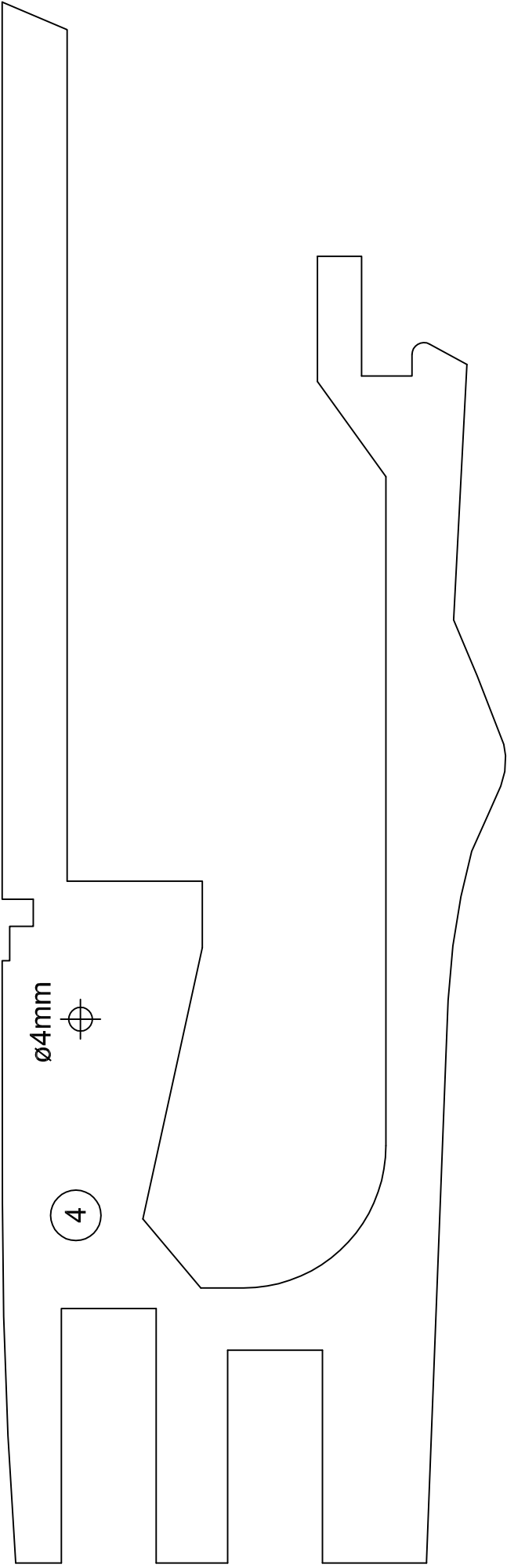

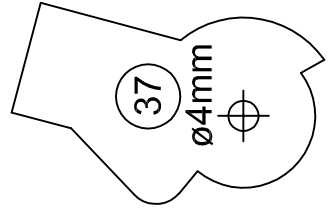
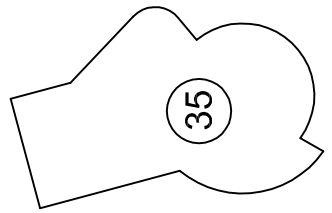
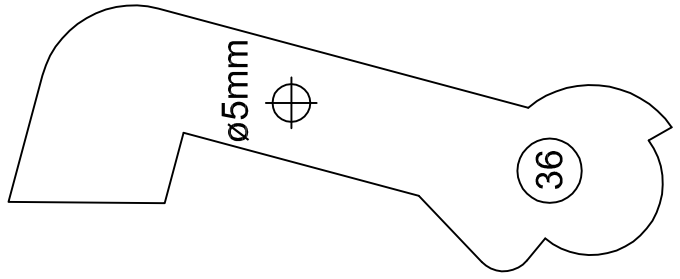
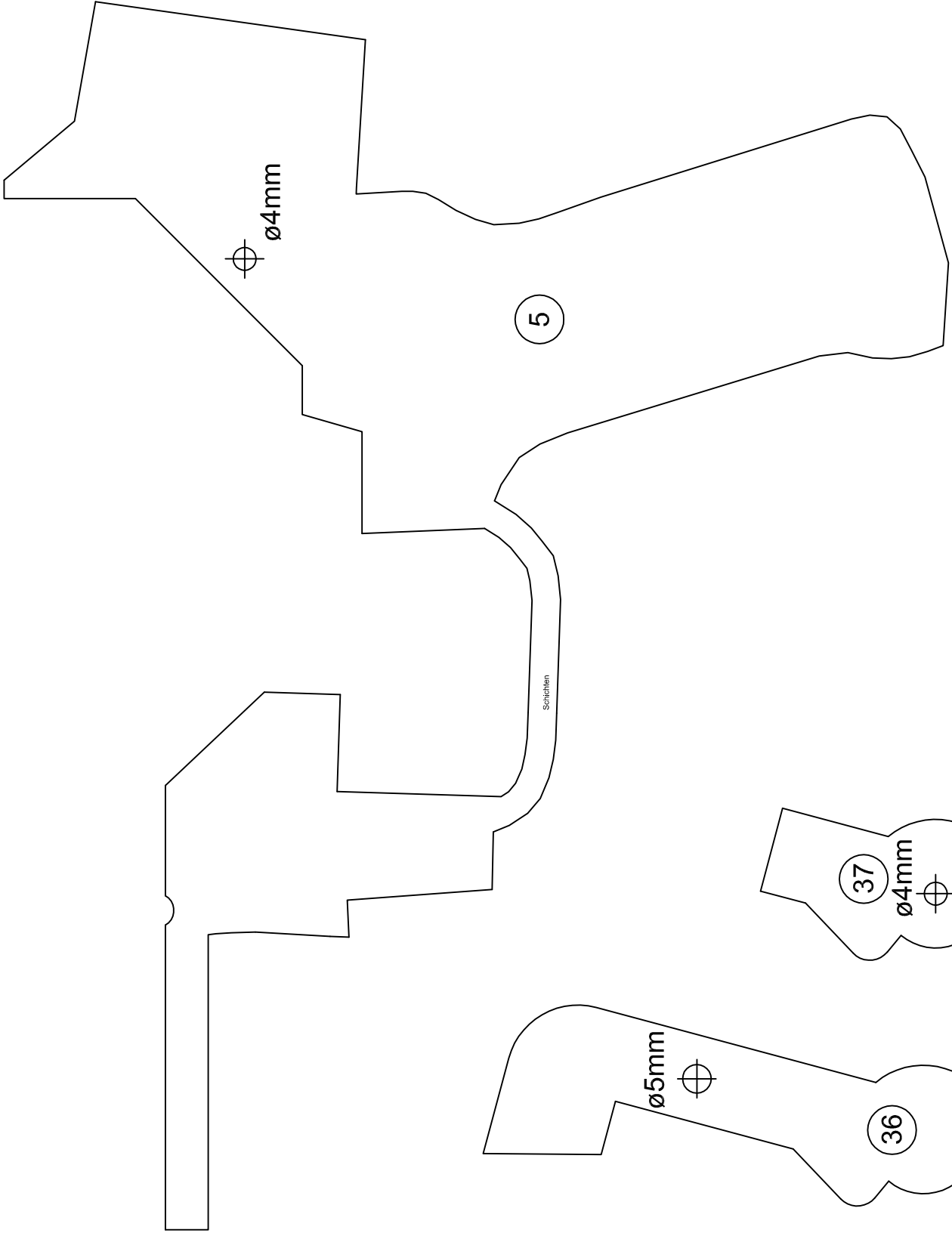

Schießen

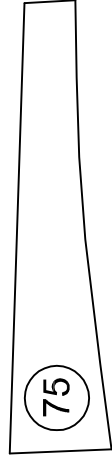
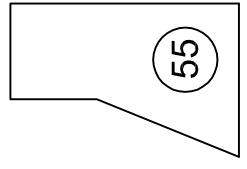
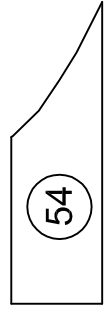
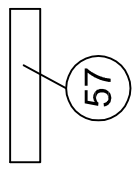
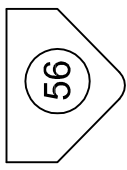
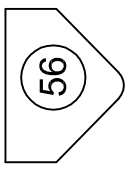
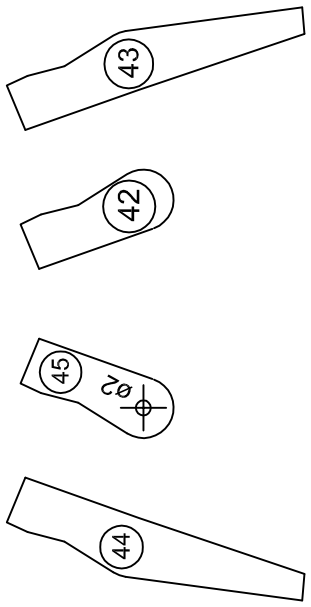
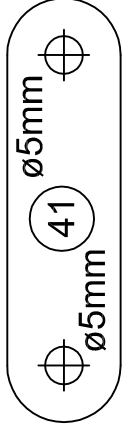
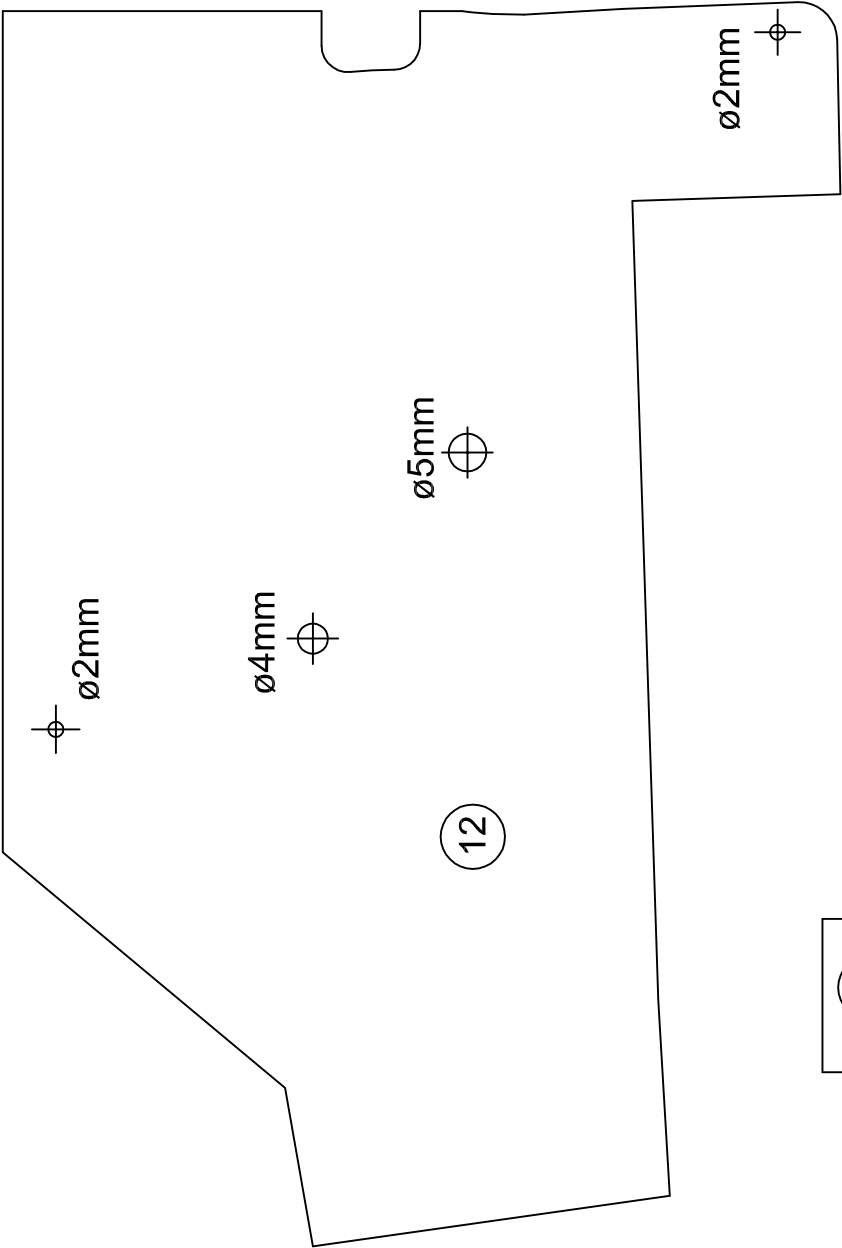

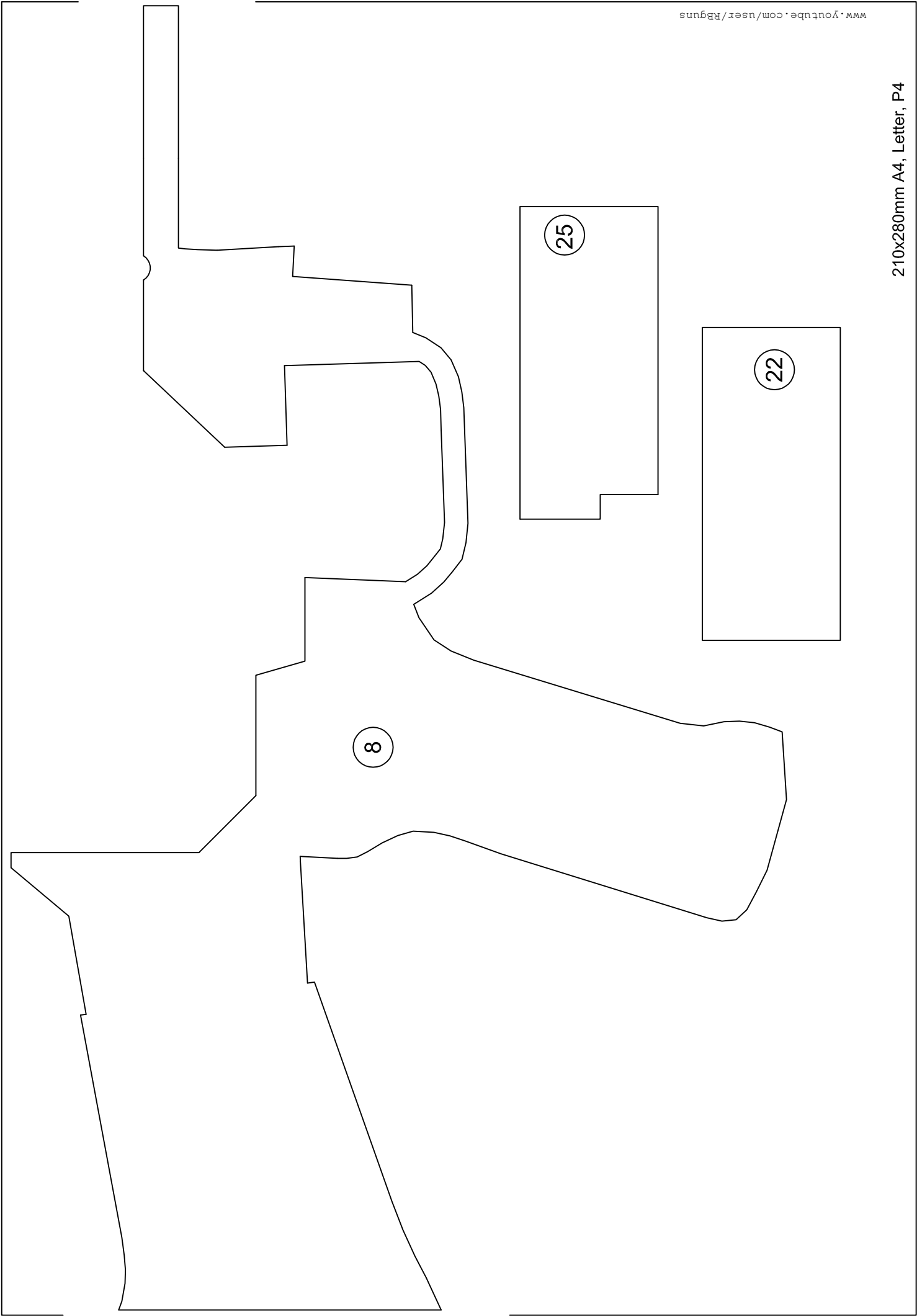

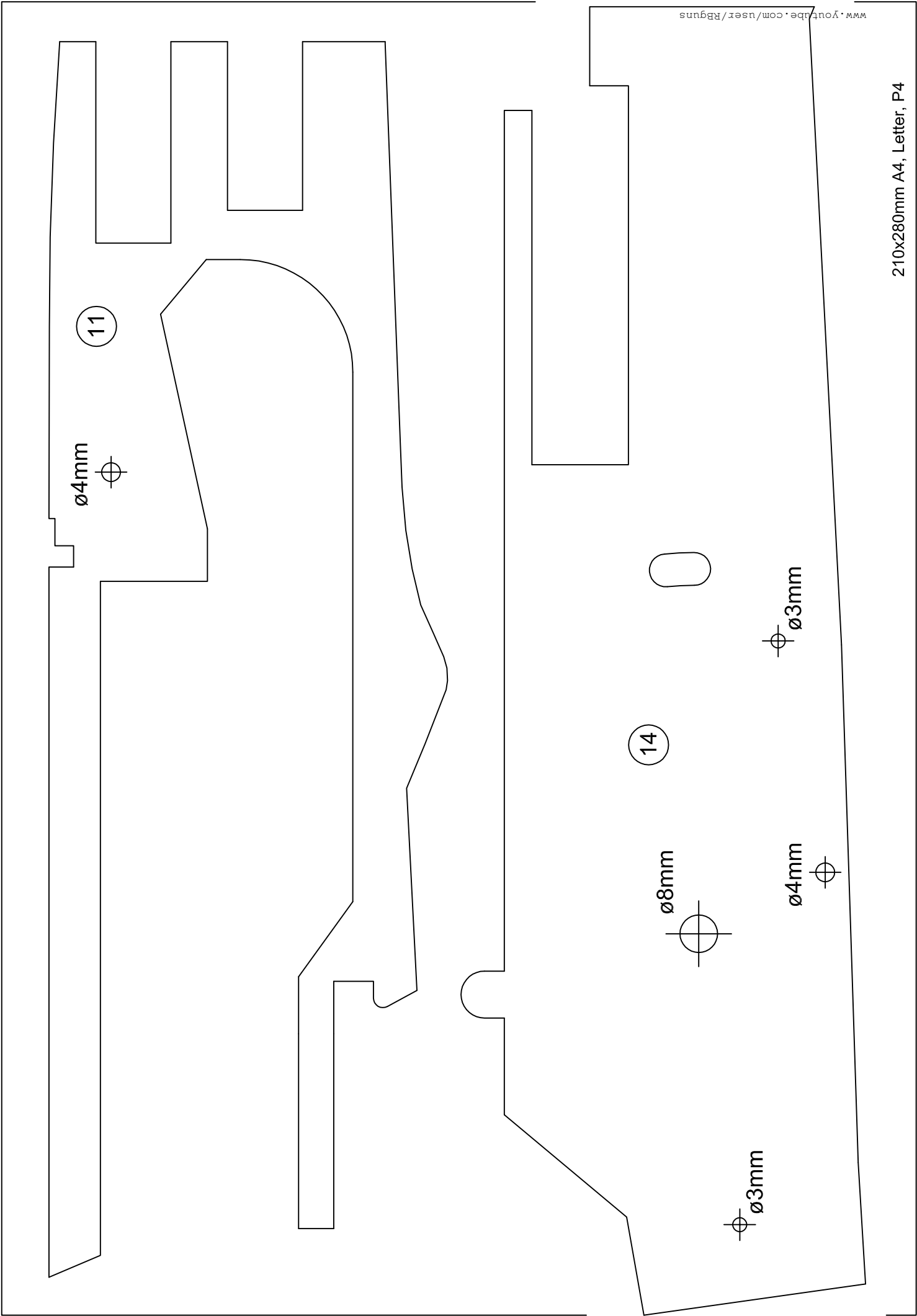

Ø4mm

11

14

Ø8mm

Ø3mm

Ø4mm

Ø3mm

www.youtube.com/user/RBguns

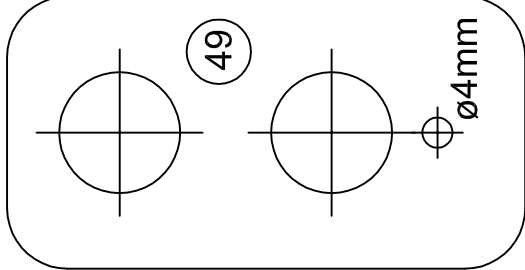
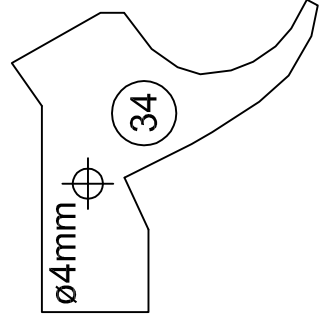
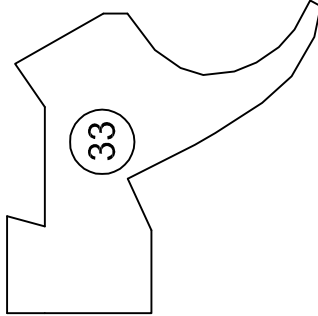
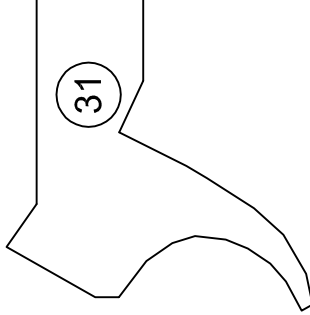
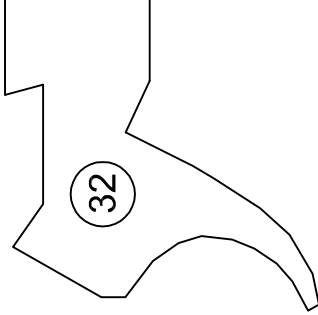
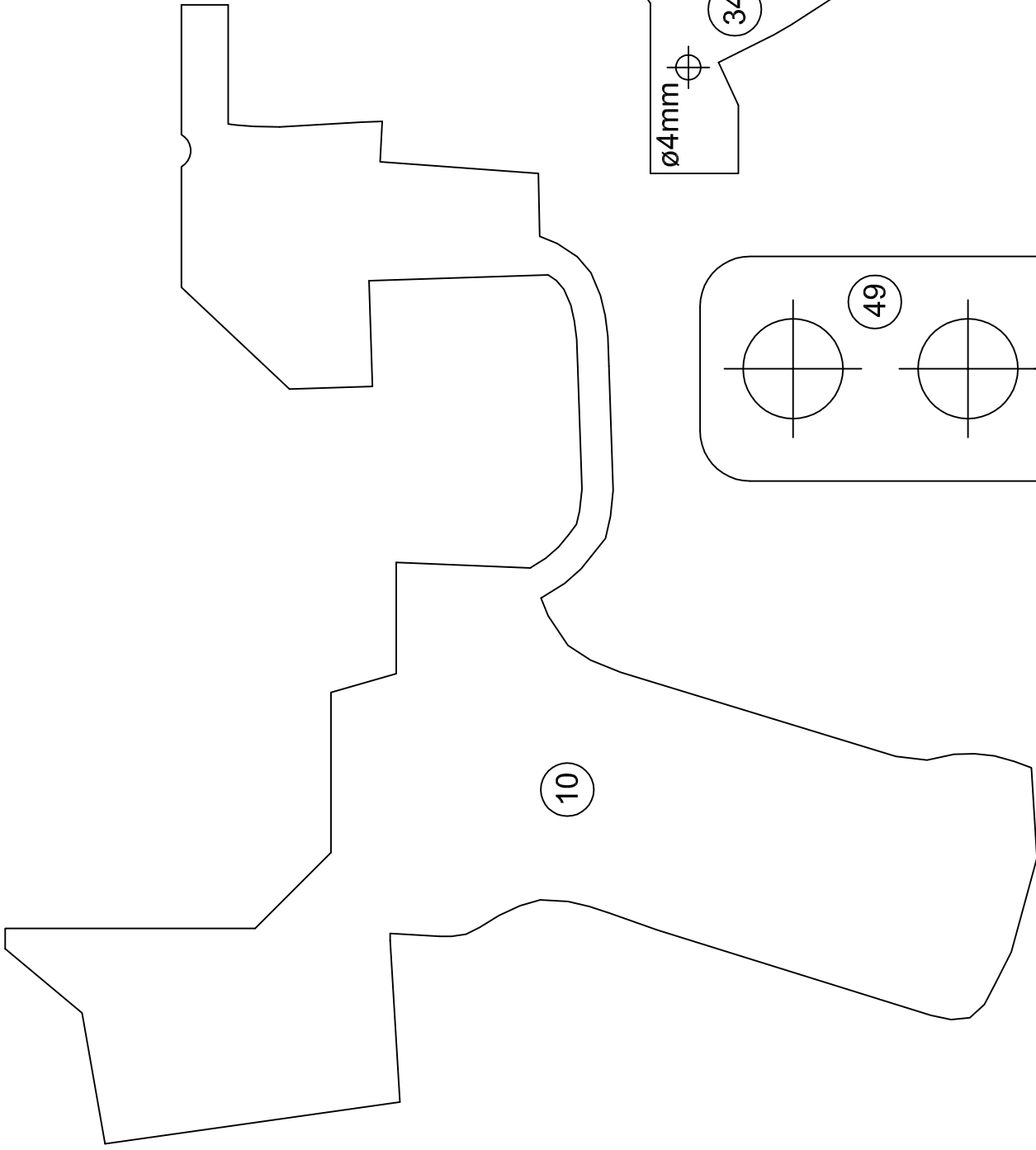

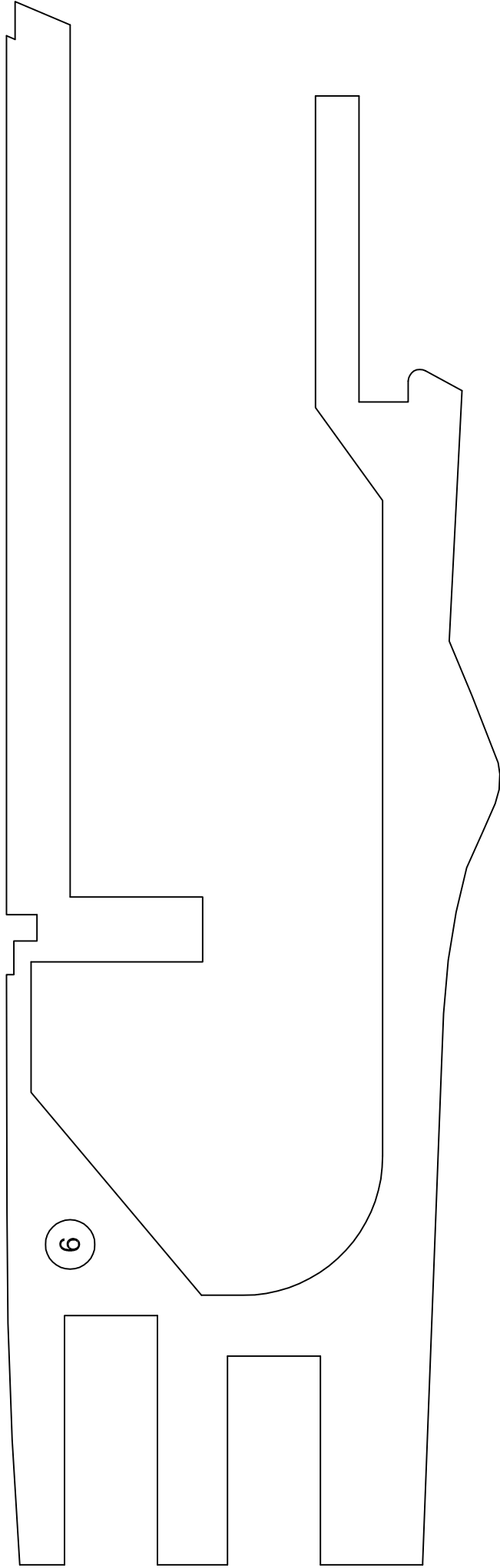

6

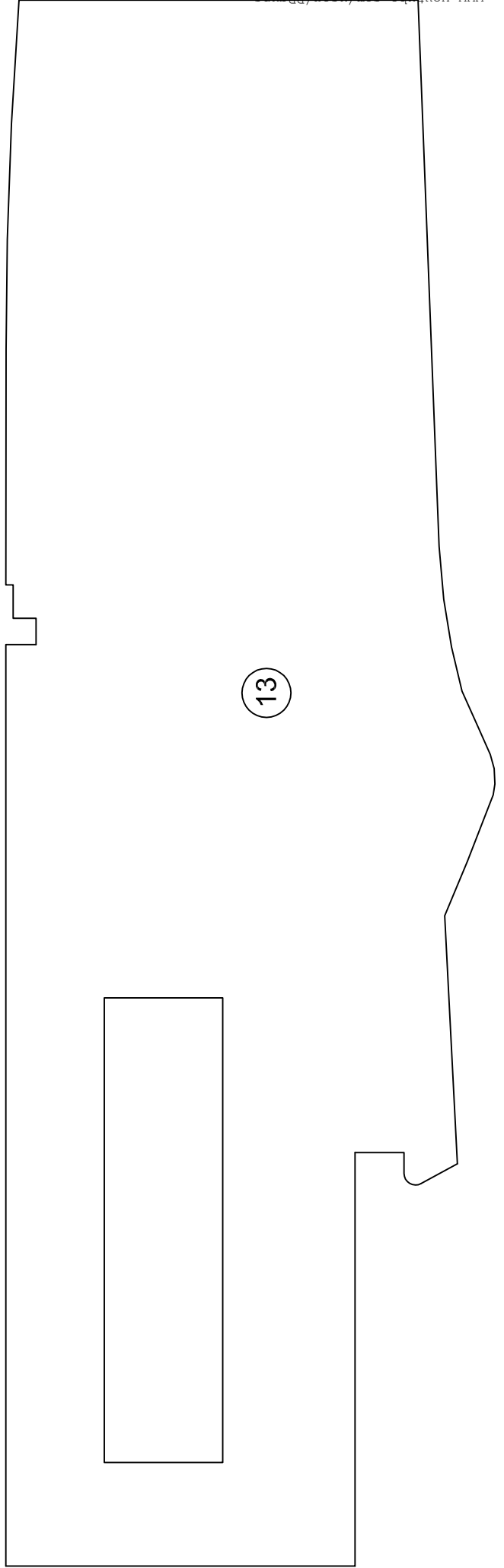

13

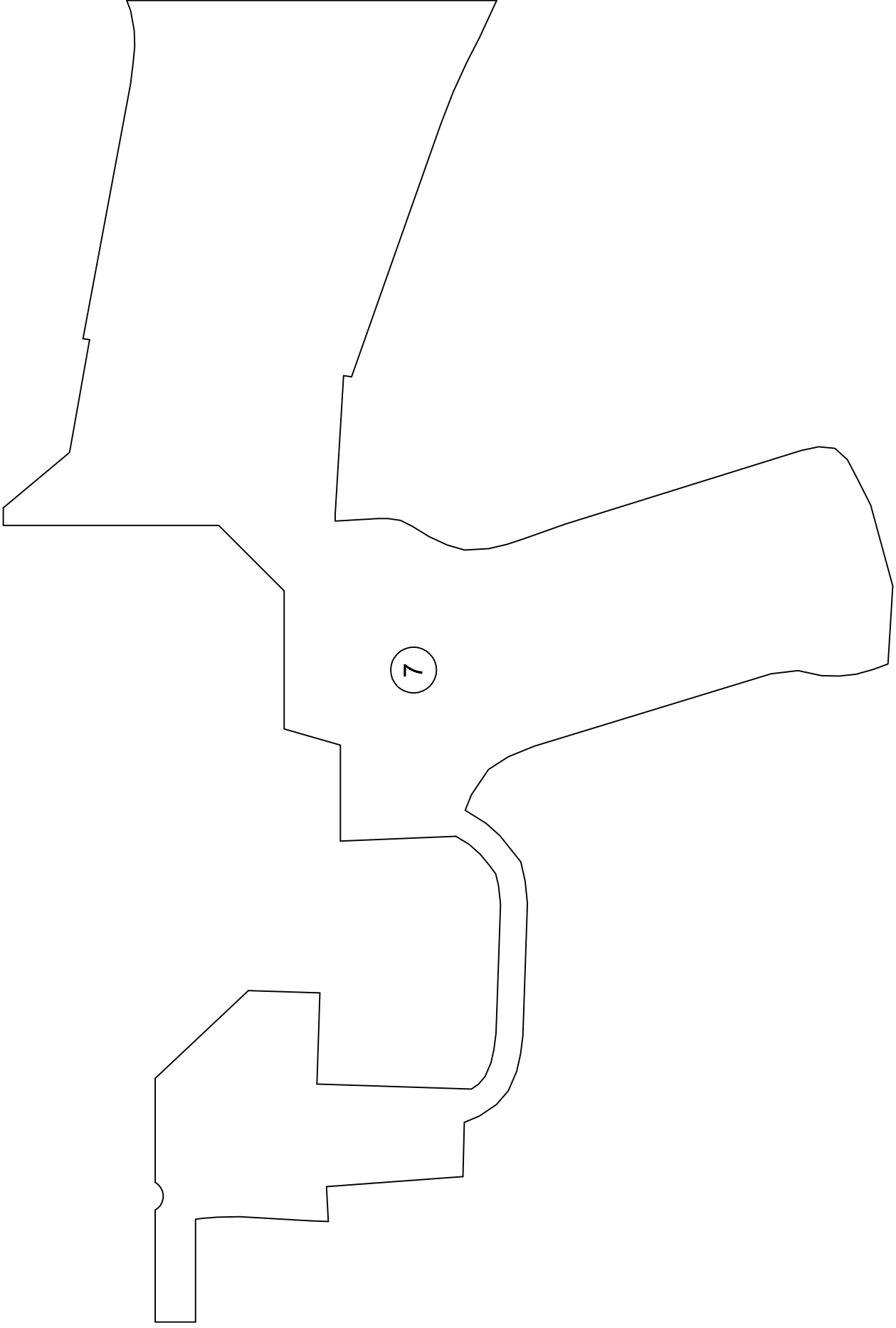

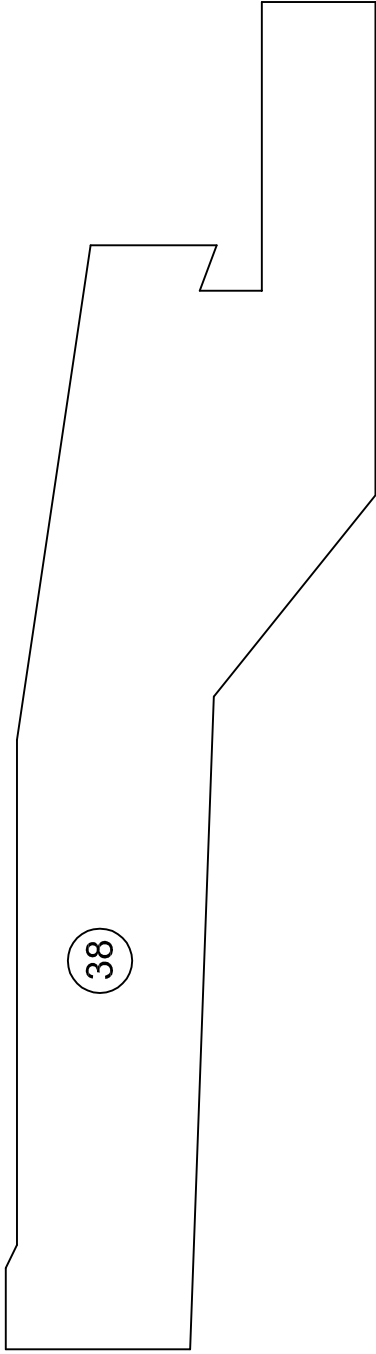

38

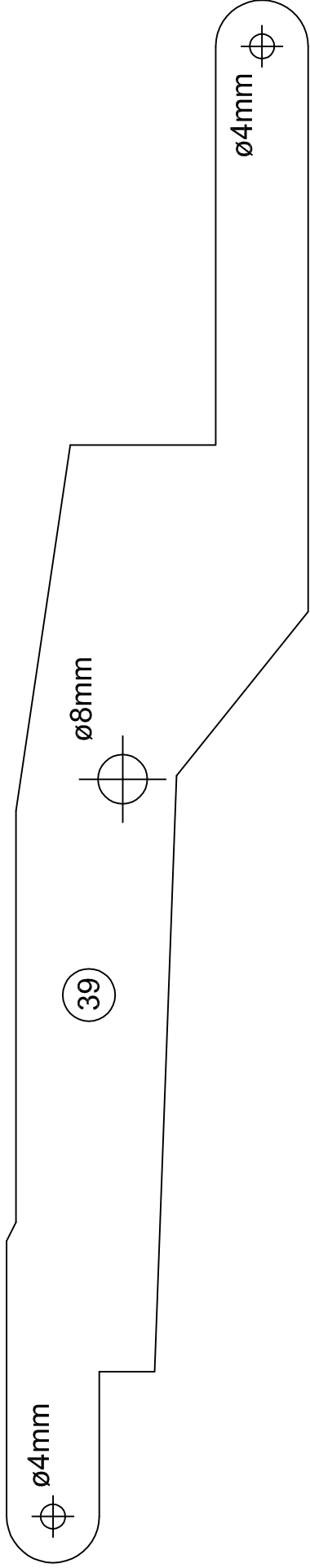

39

$\phi 4\text{mm}$

$\phi 8\text{mm}$

$\phi 4\text{mm}$

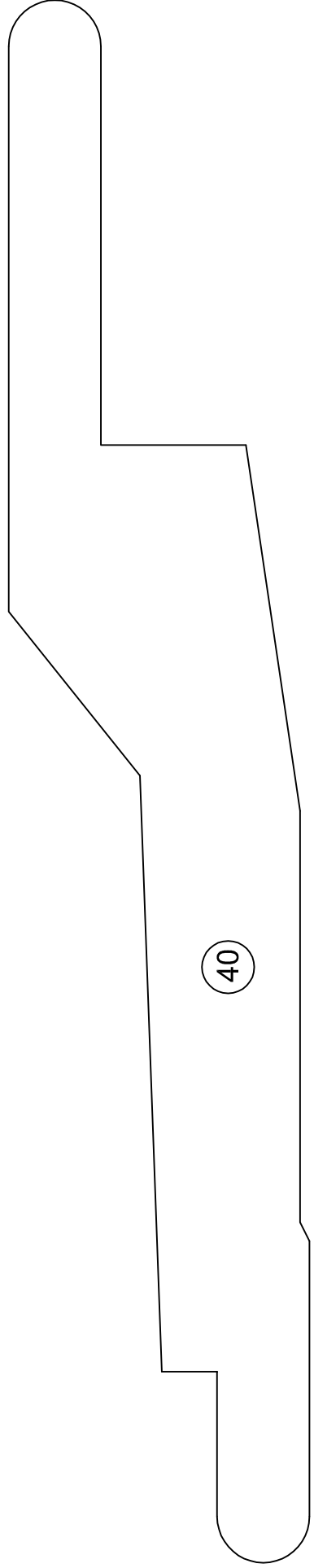

40



14mm Hardwood

15

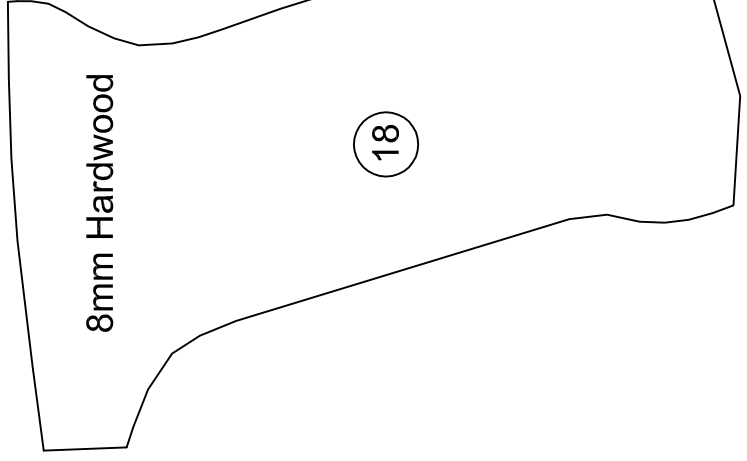

8mm Hardwood

18

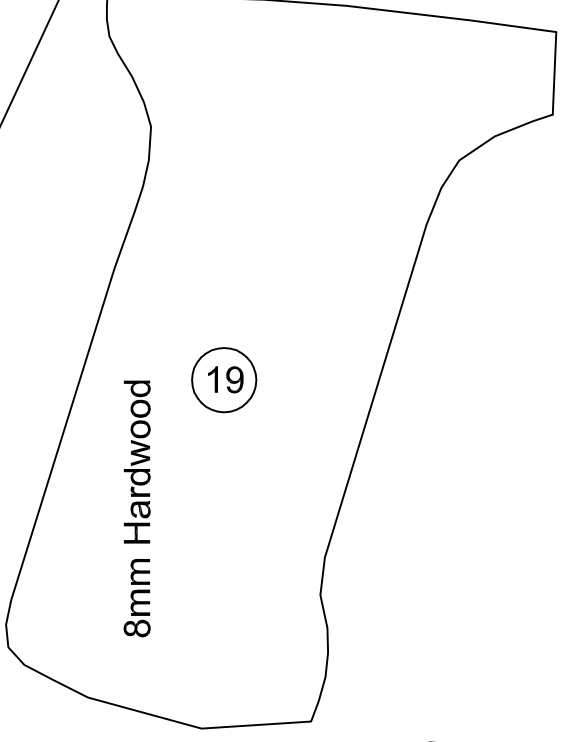

8mm Hardwood

19

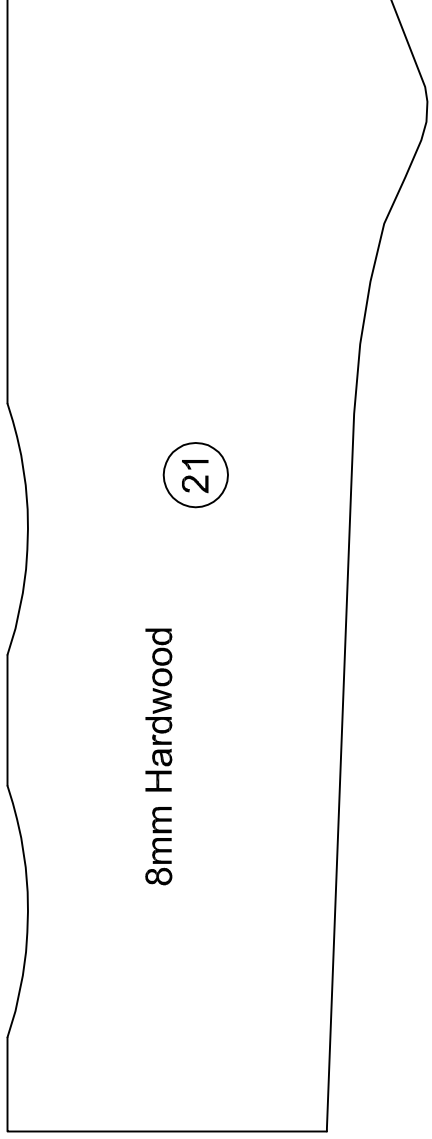
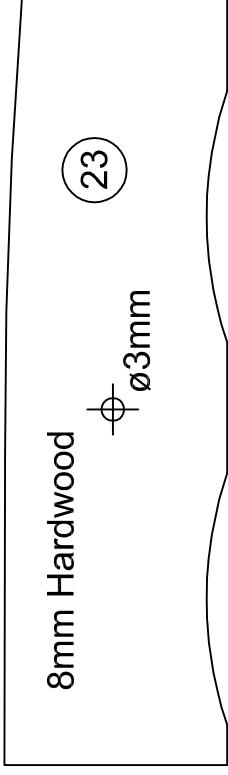
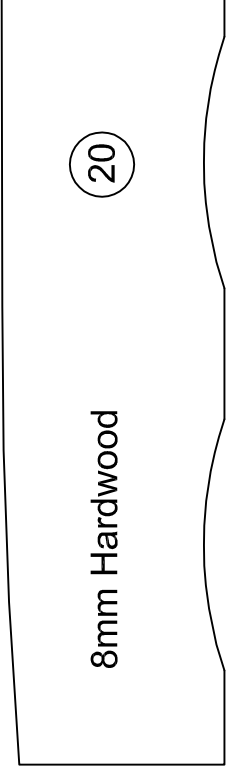
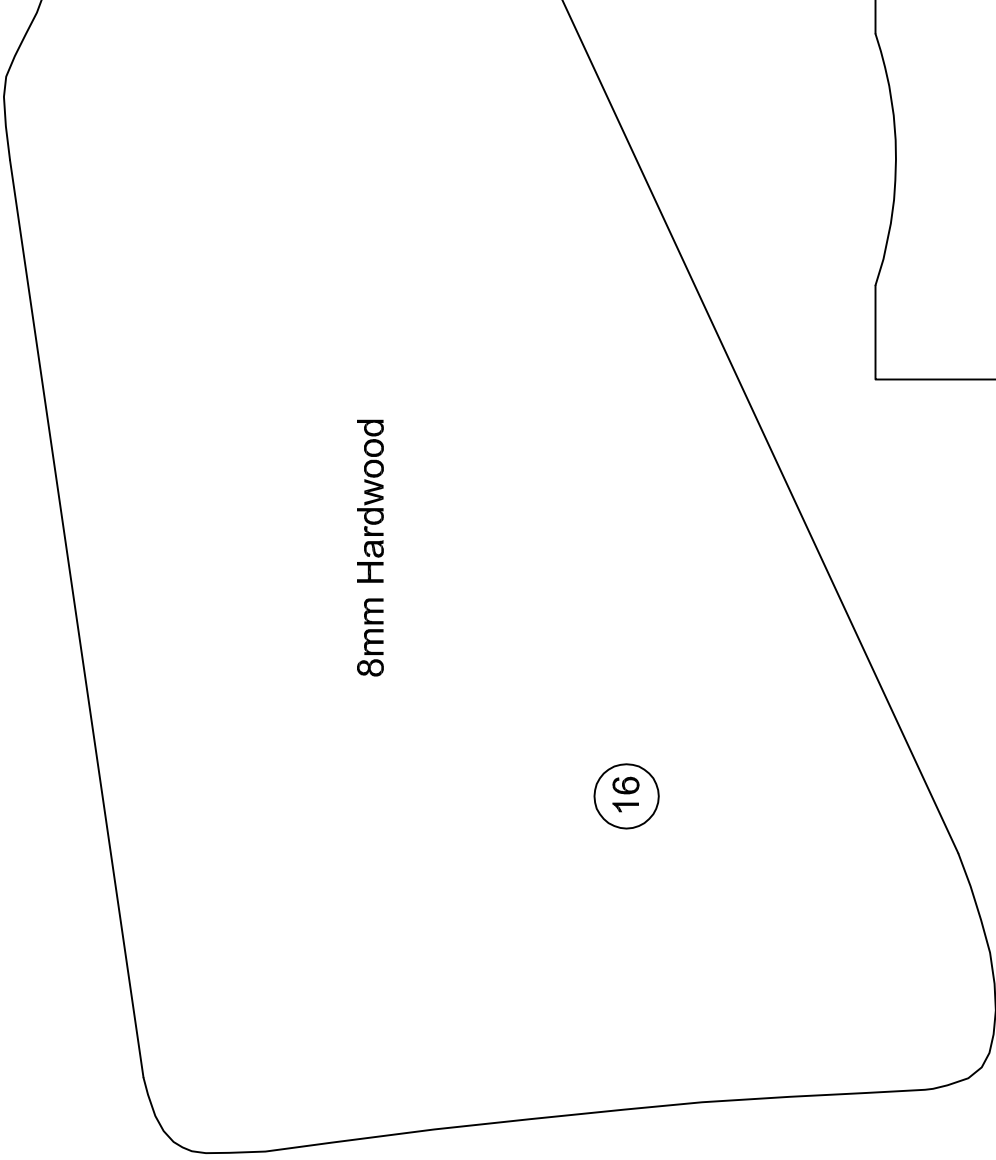

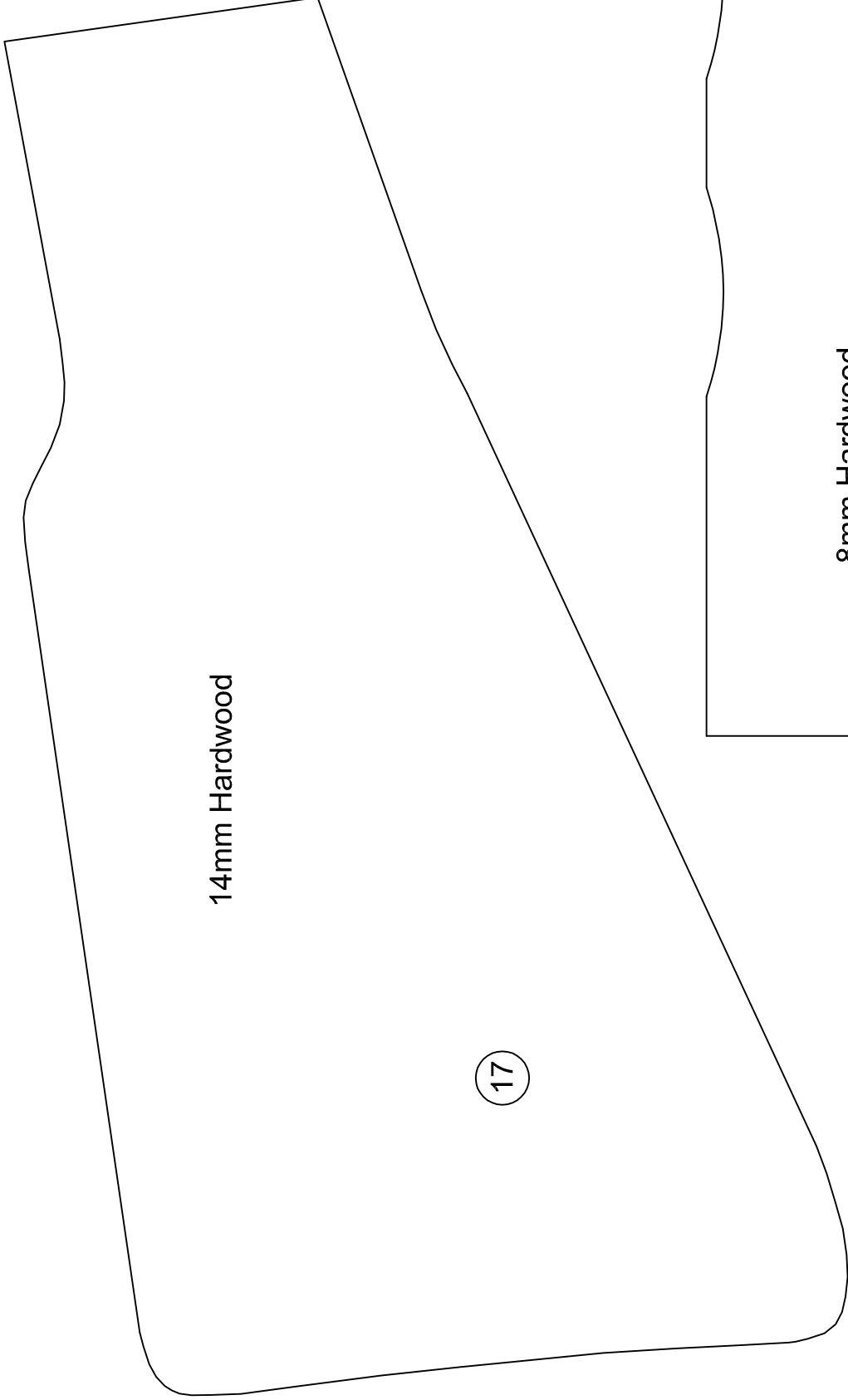

14mm Hardwood

17

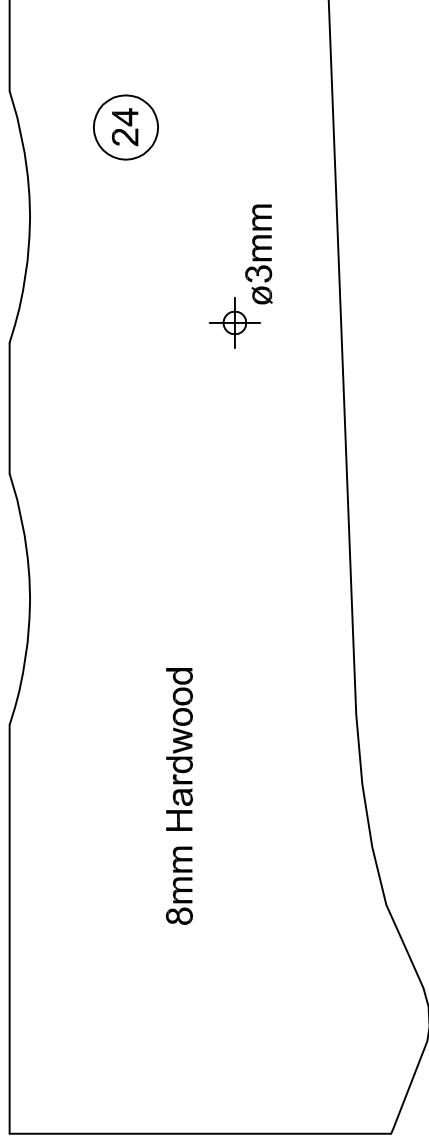

8mm Hardwood

24

ø3mm

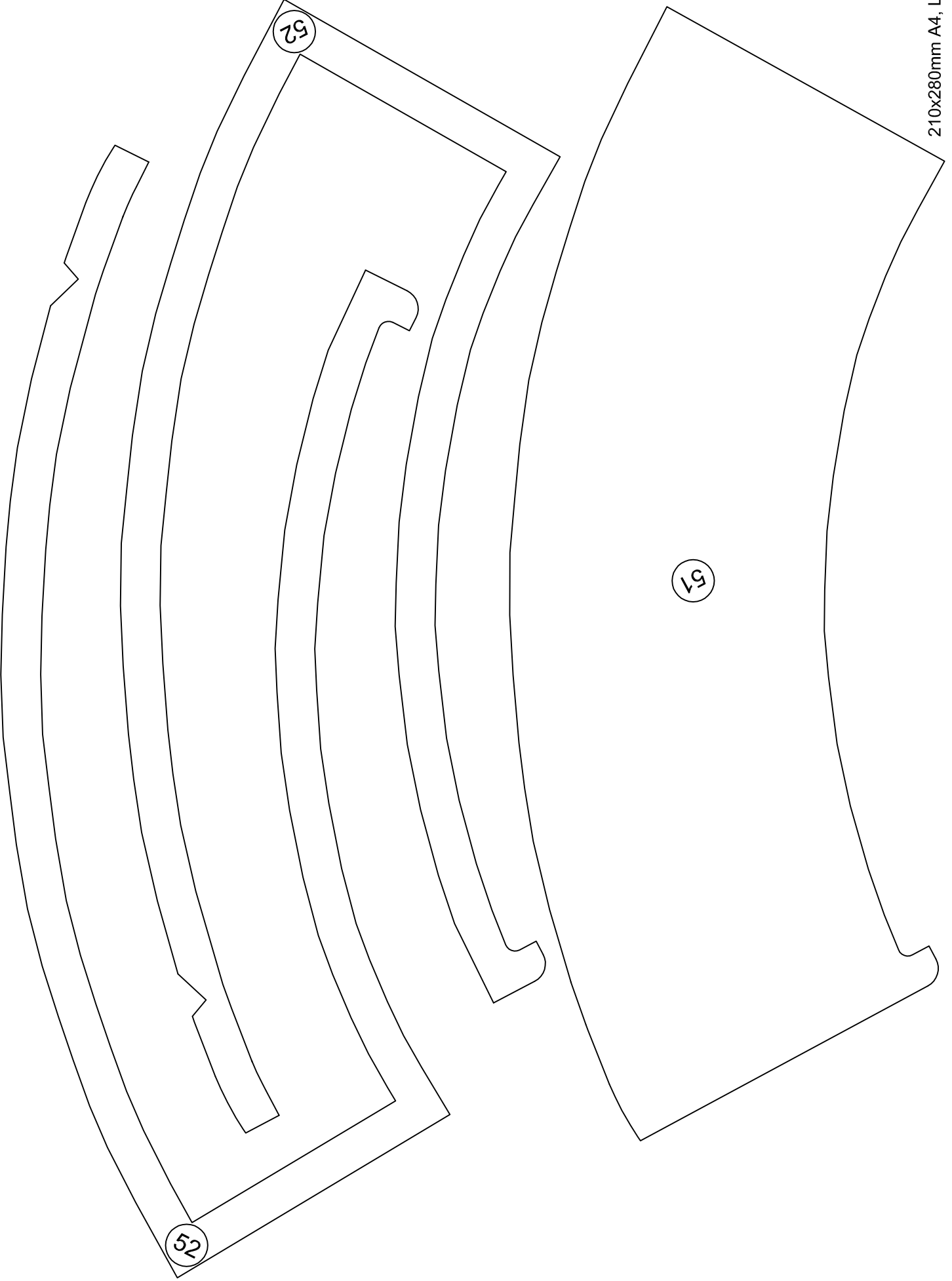

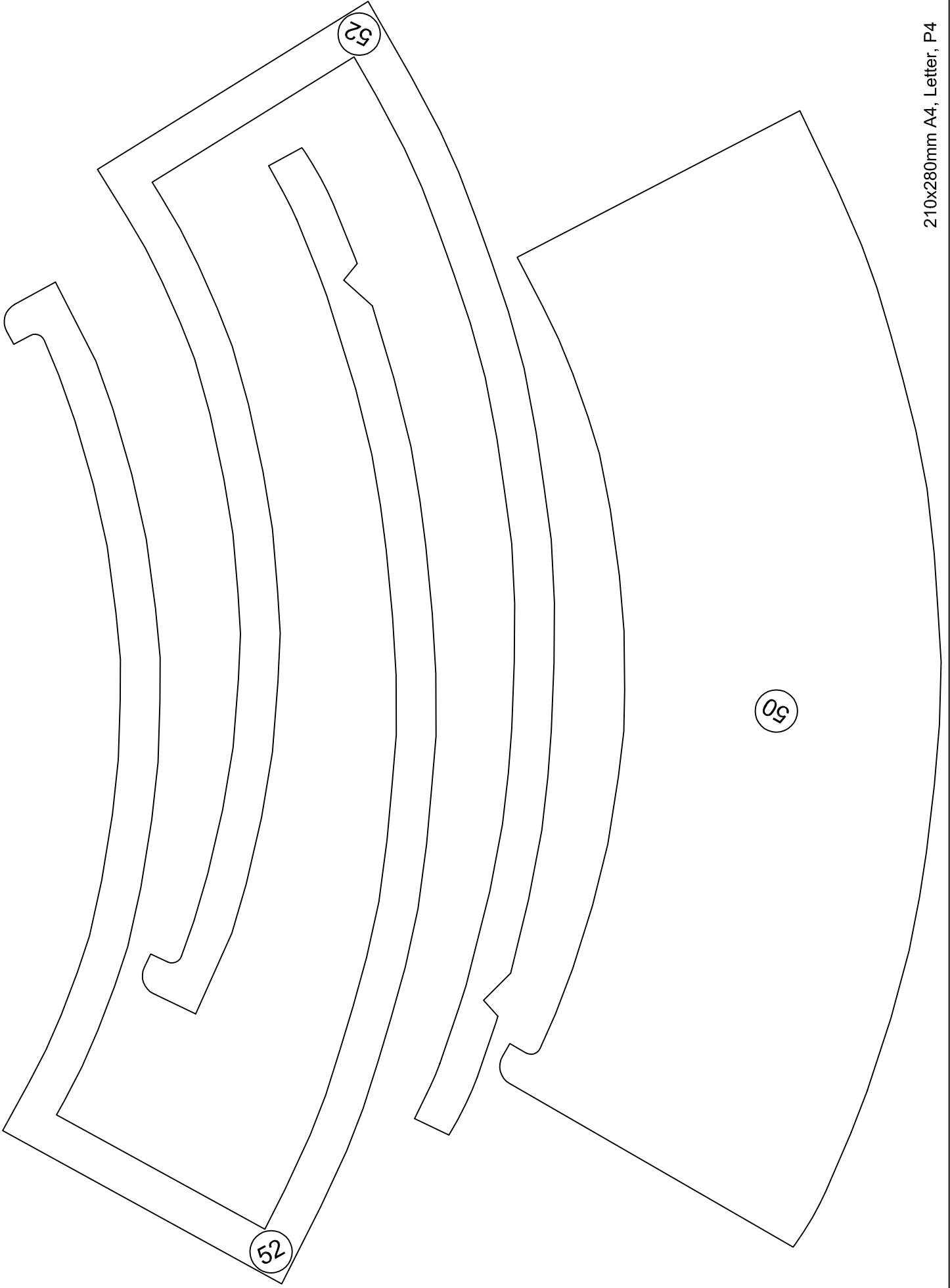

58

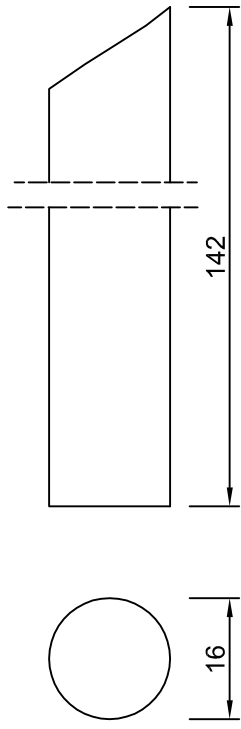

59

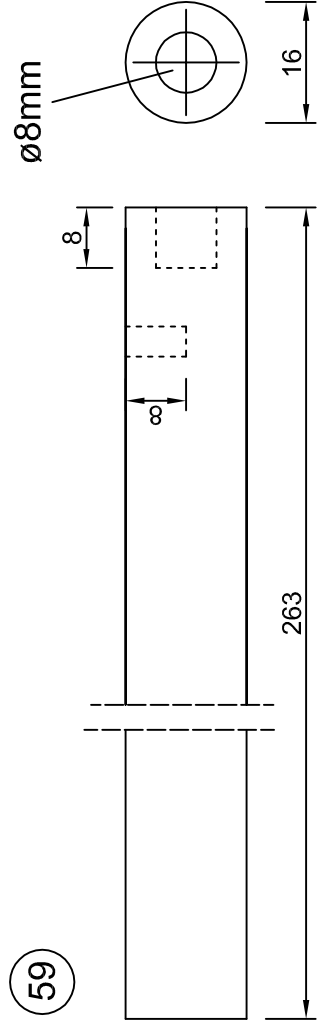

60

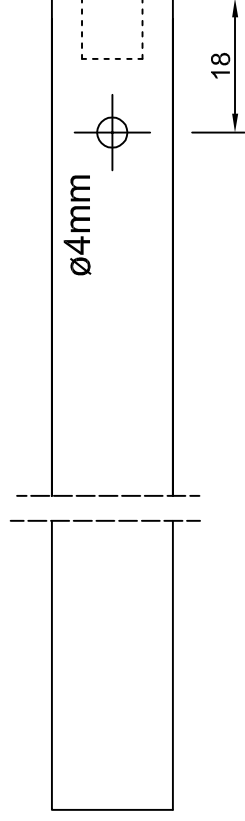
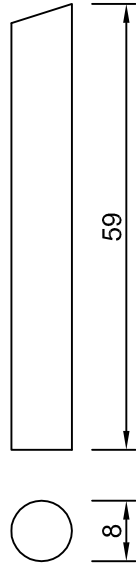

61

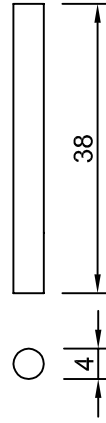

62 steel

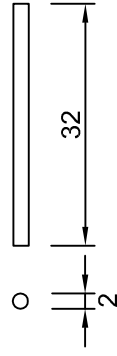

63

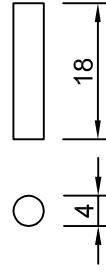

2x 64

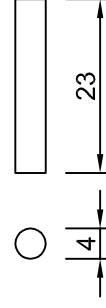

65

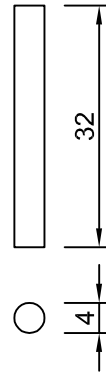

2x 66

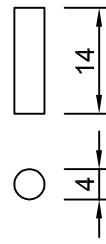

67

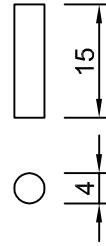

68 steel

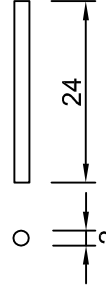

69

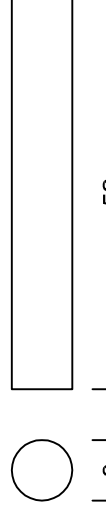

70

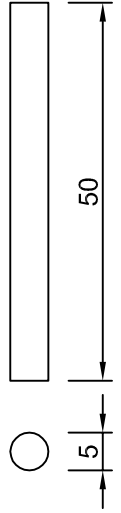

71 Spring

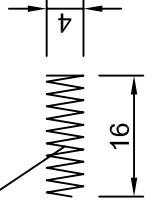

72

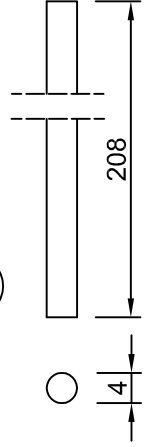

73

