

150

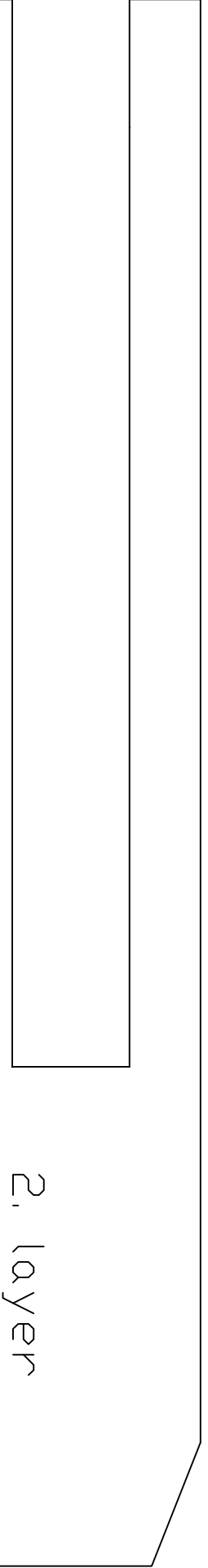

2. layer

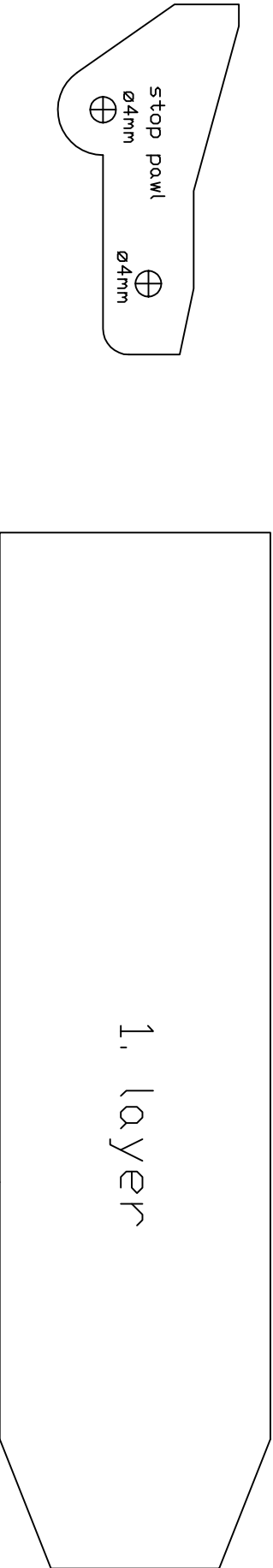

1. layer

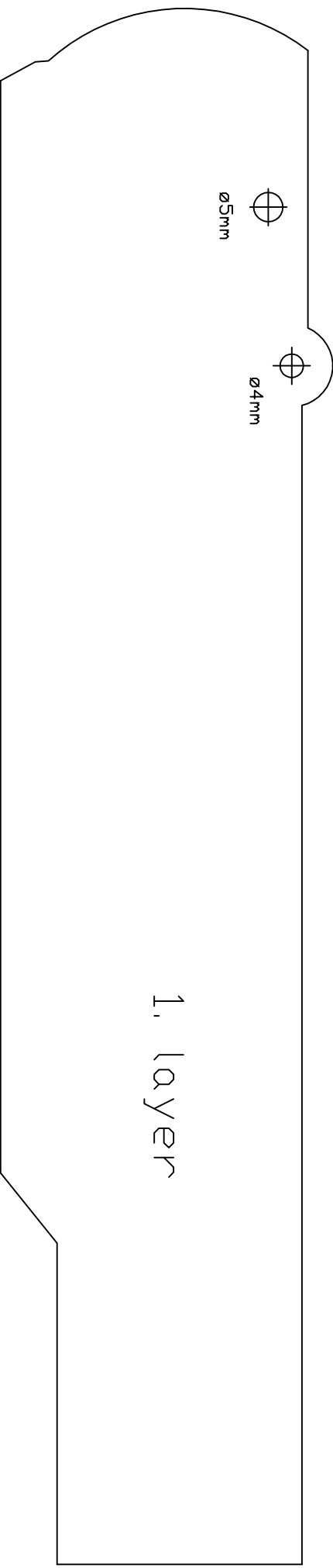
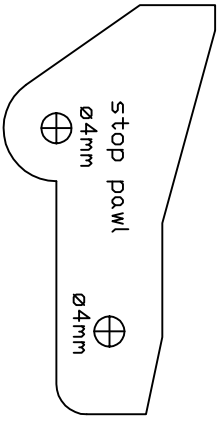

1. layer

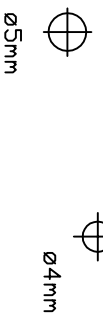

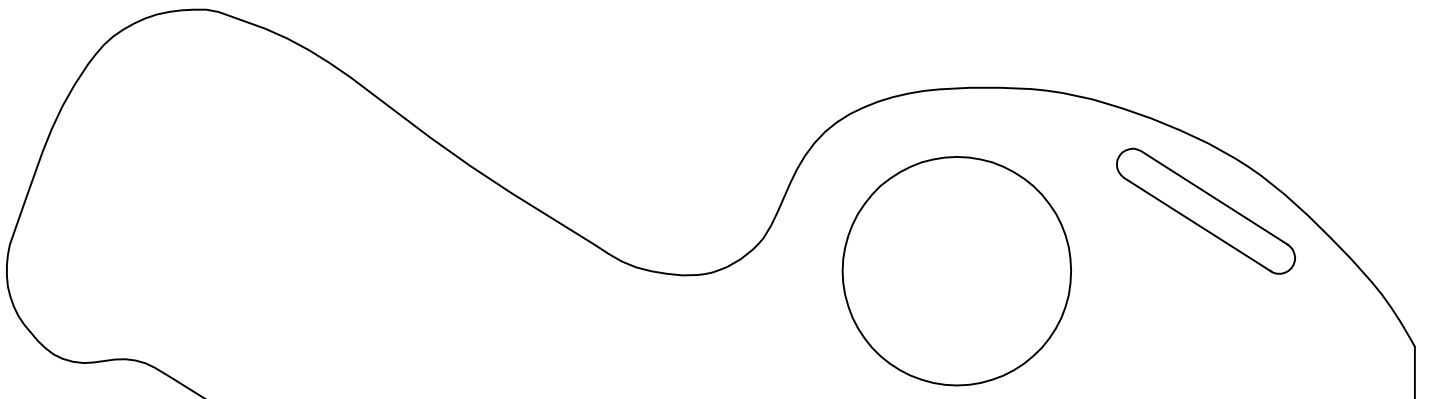

⊕
ø4mm

3. layer

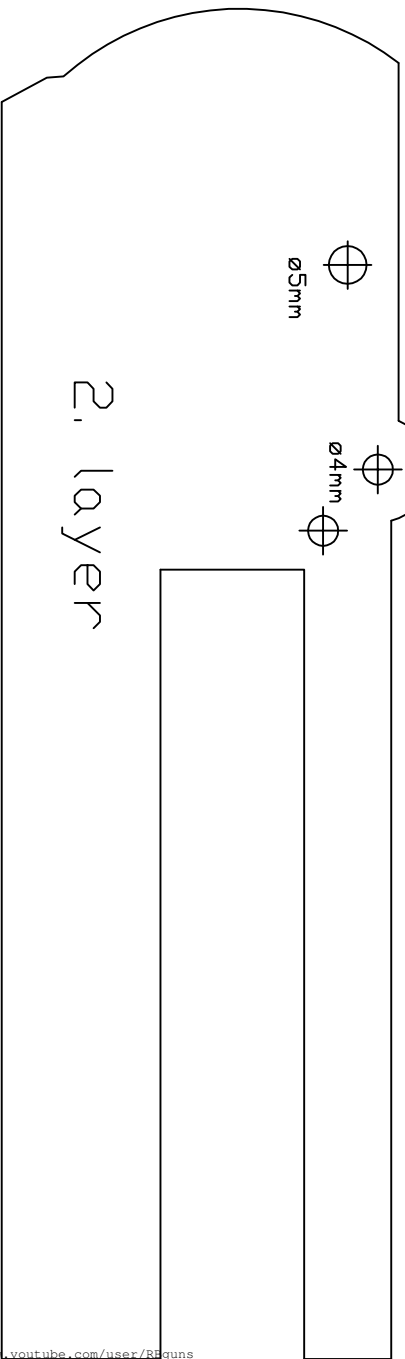
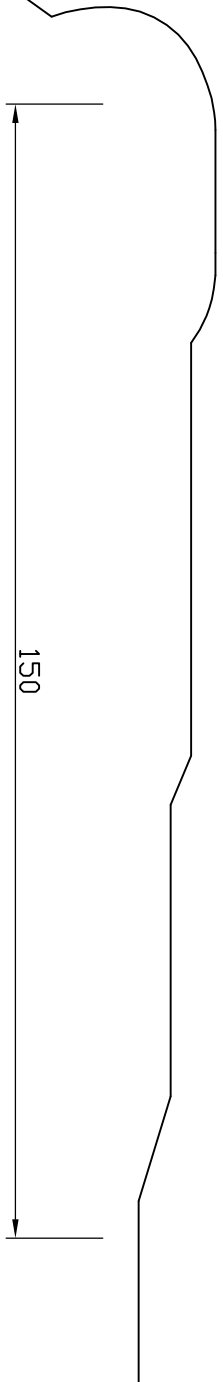

2. layer

3. layer

4. layer

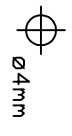
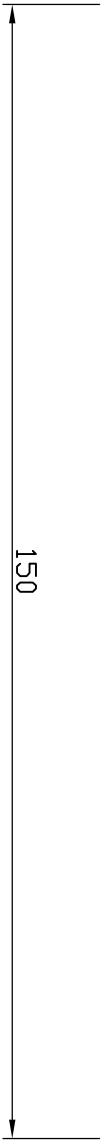
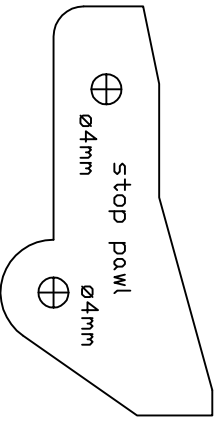

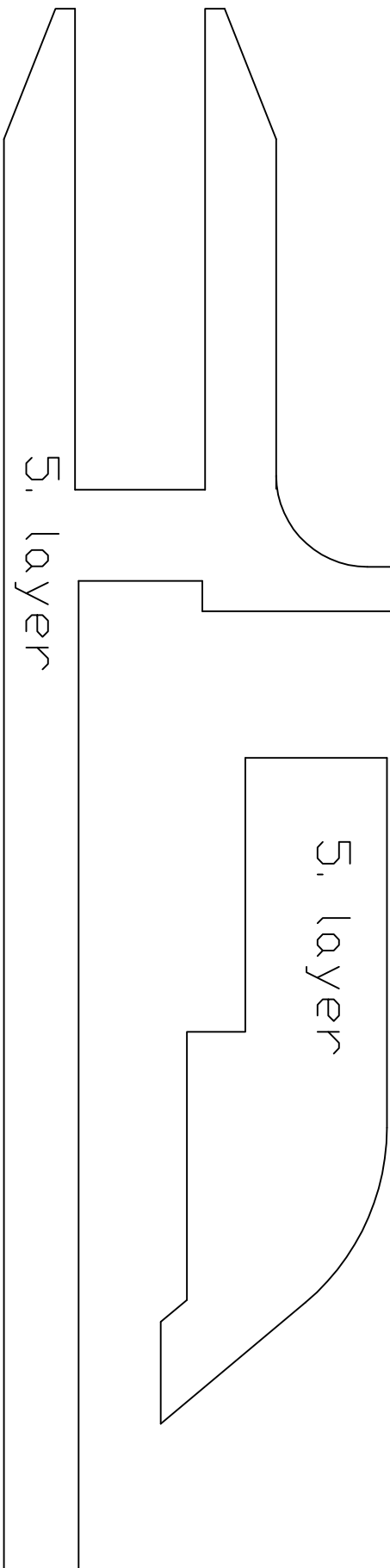
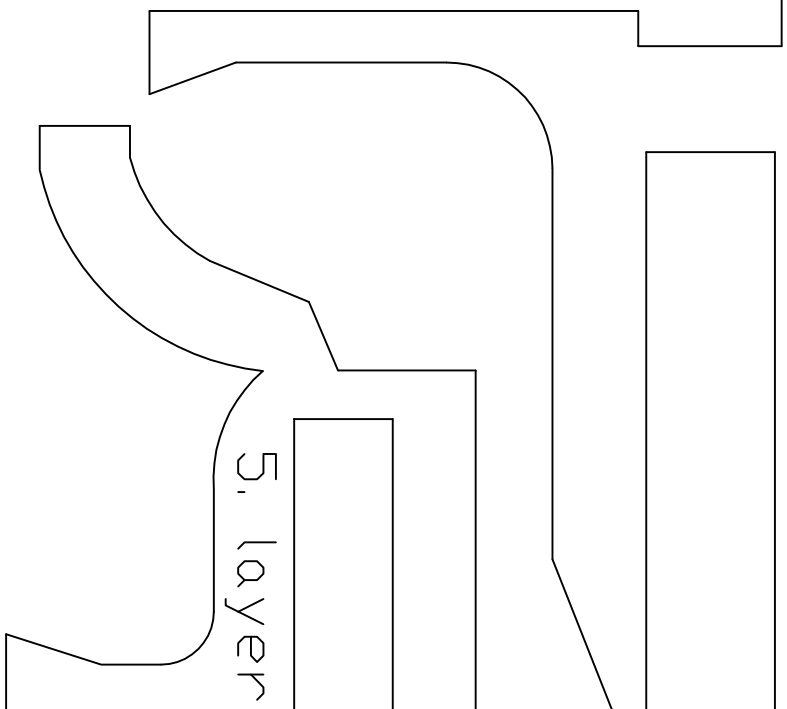
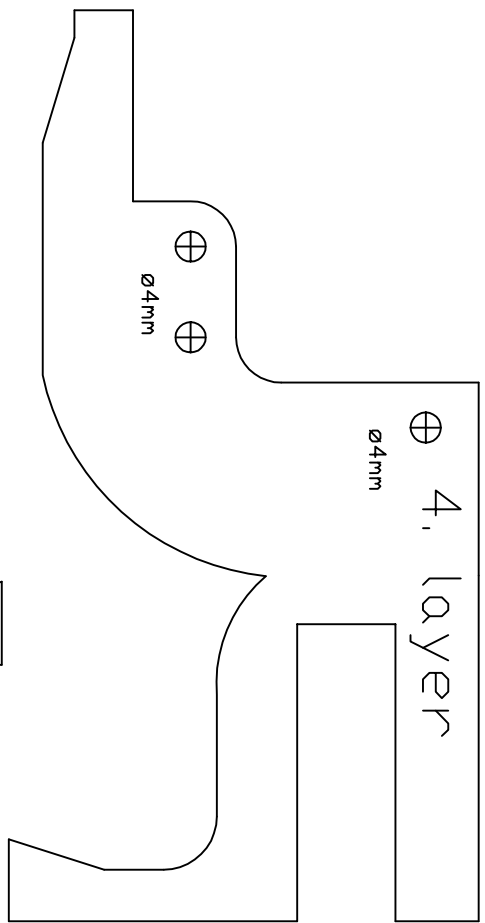
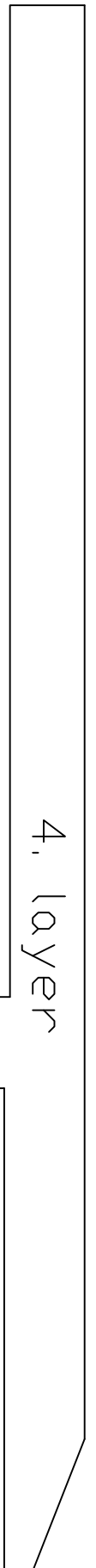

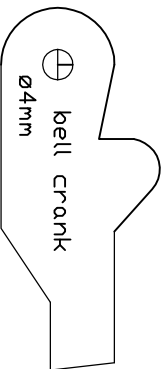
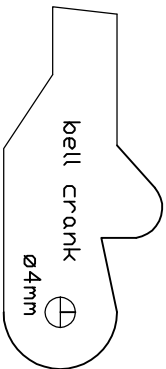
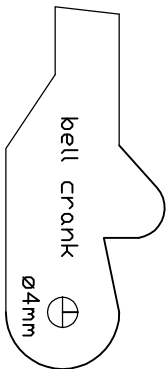
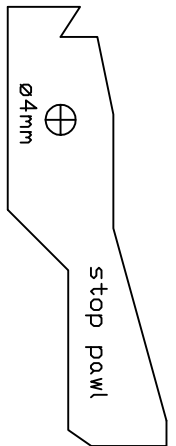
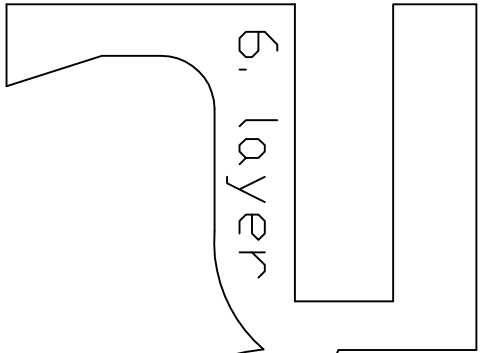
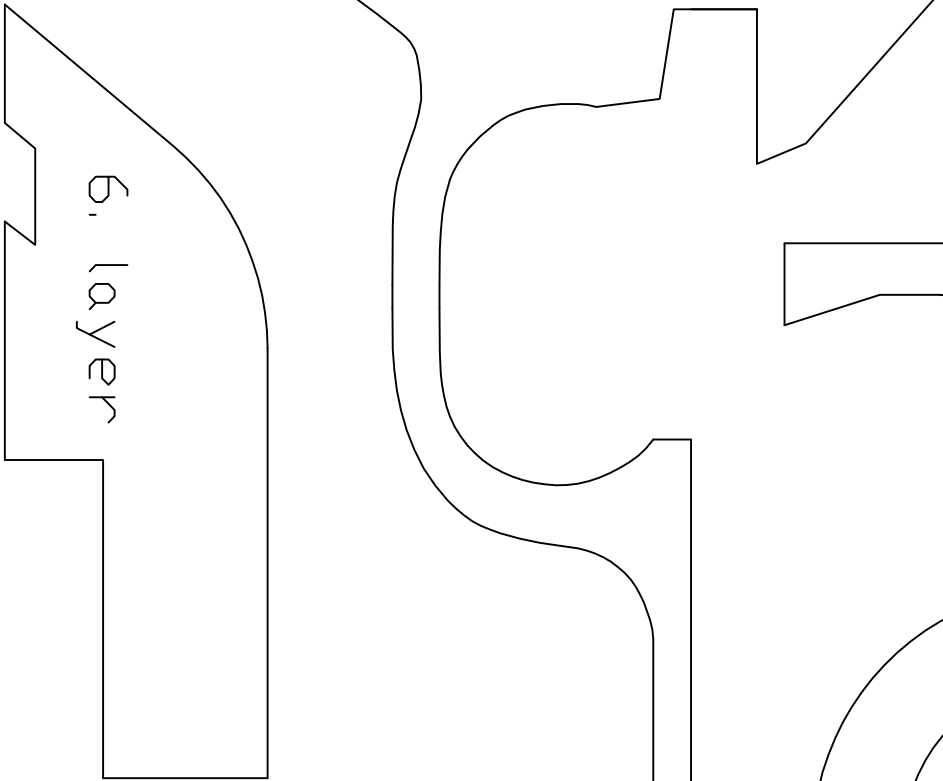
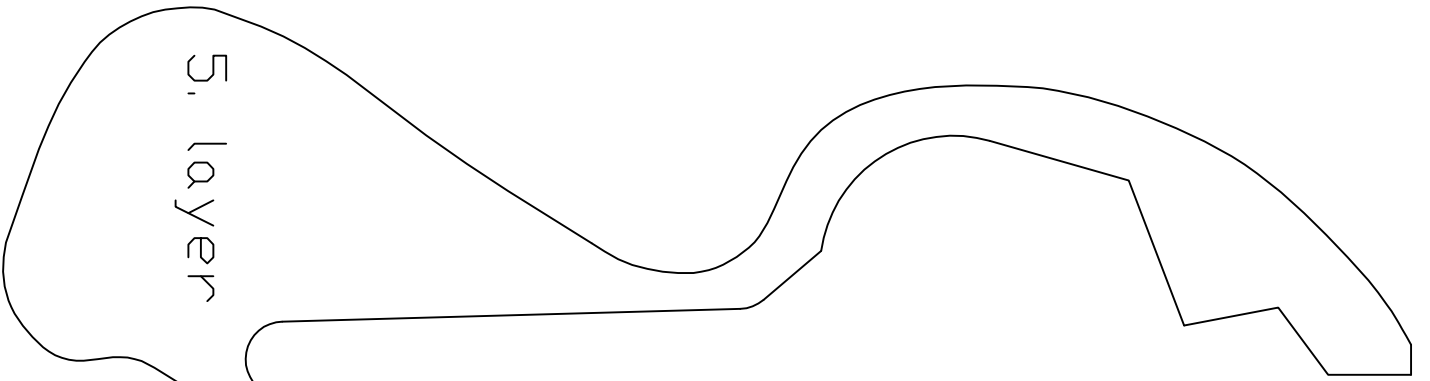



7. layer

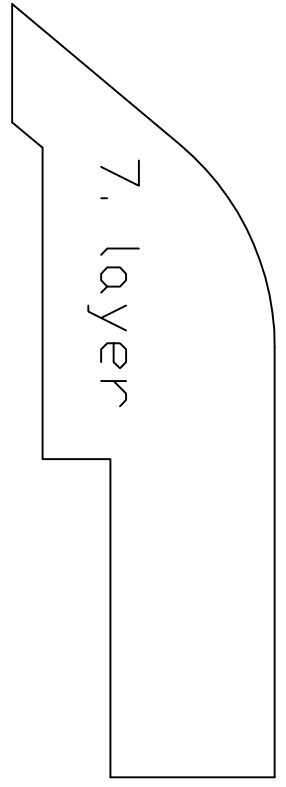
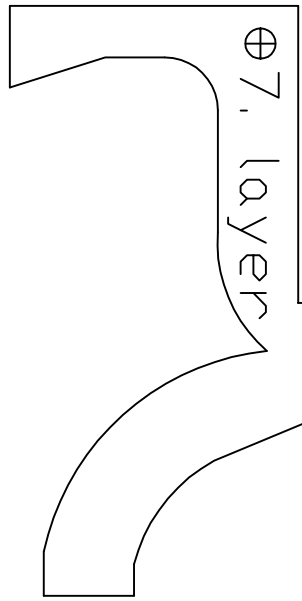

7. layer

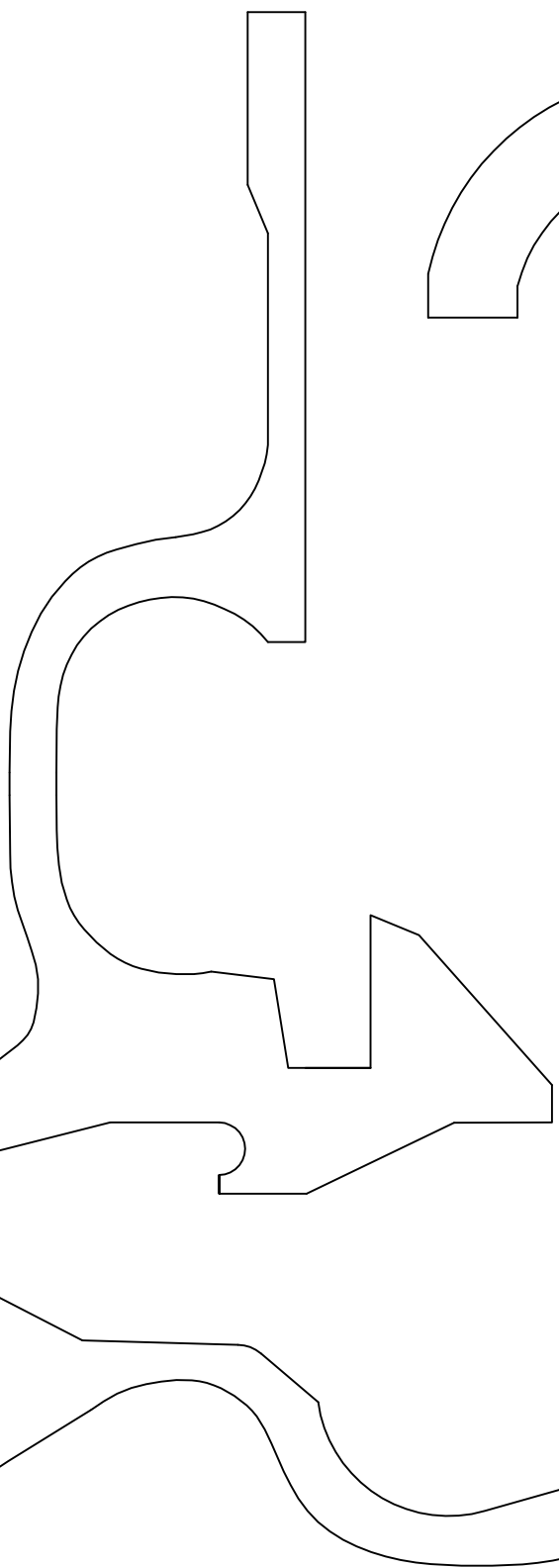

6. layer

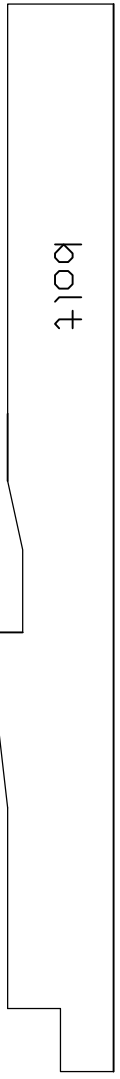

bolt

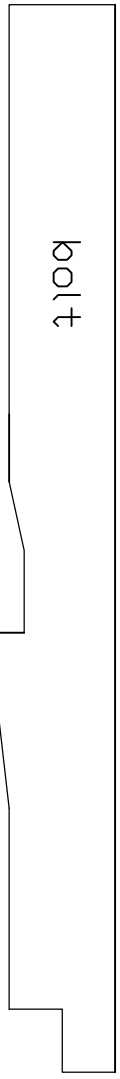

bolt

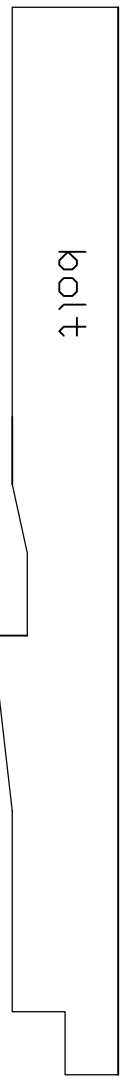

bolt

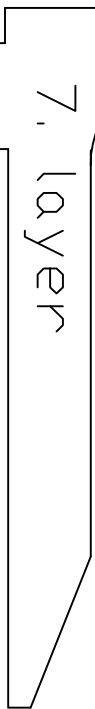
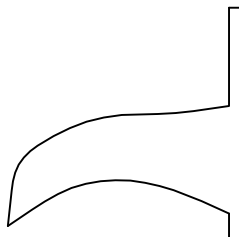
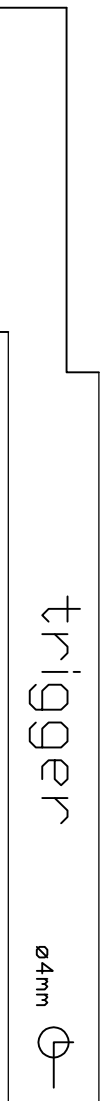
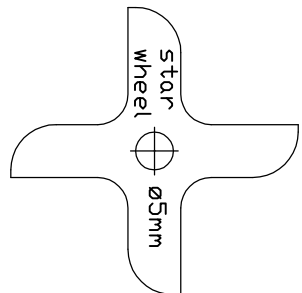
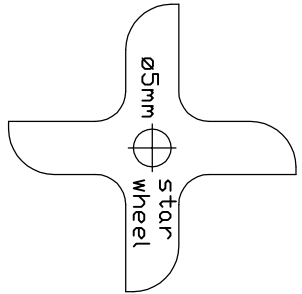
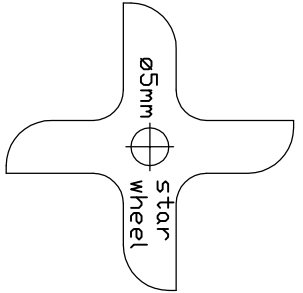
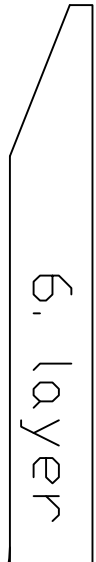

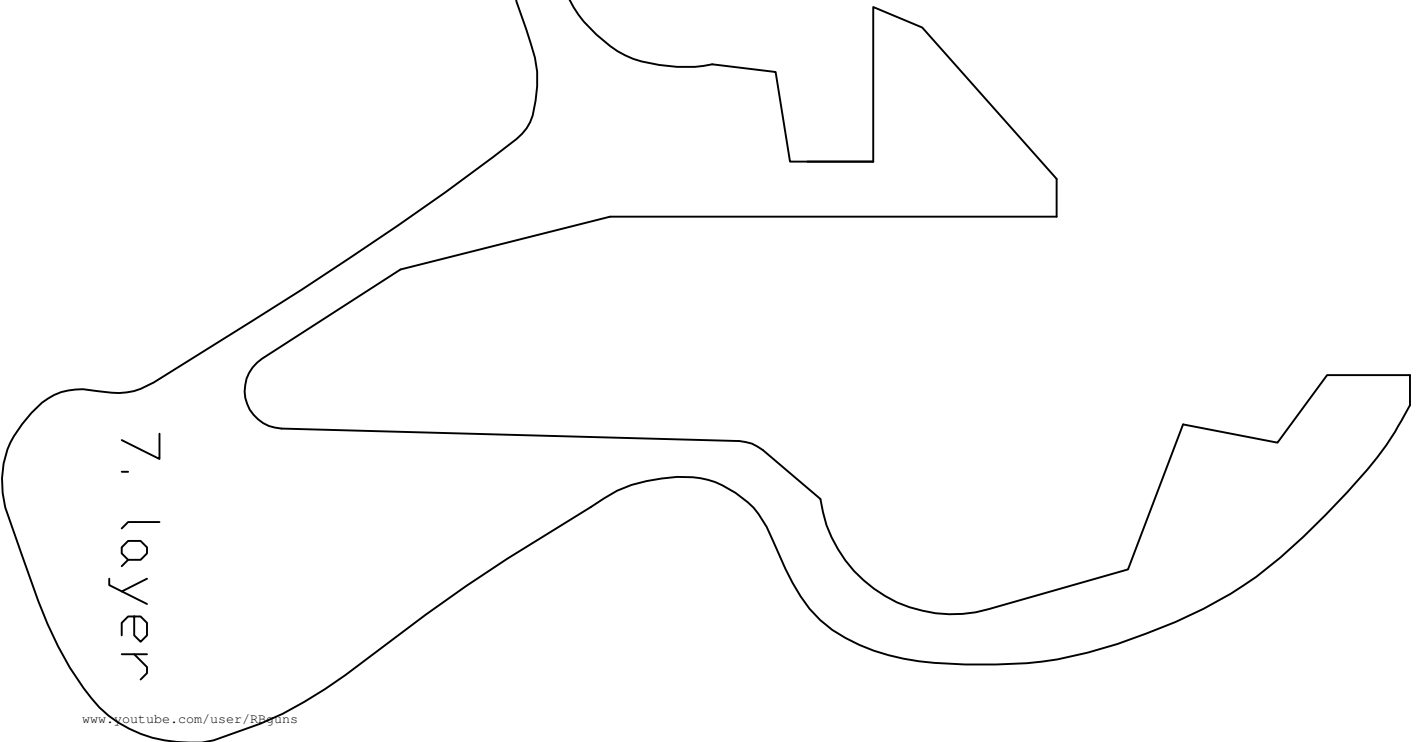
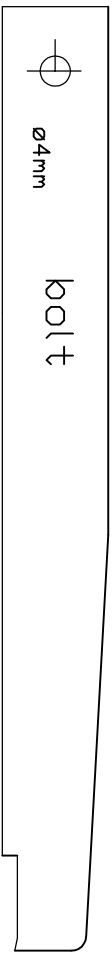
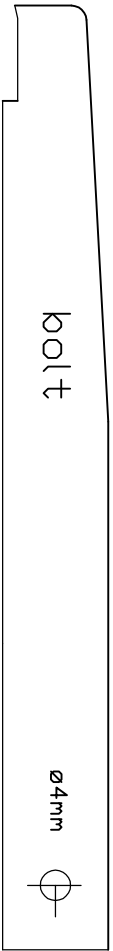
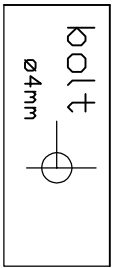
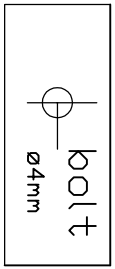
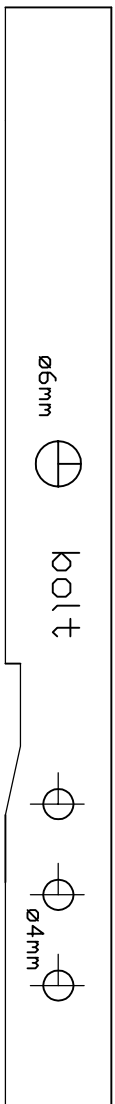
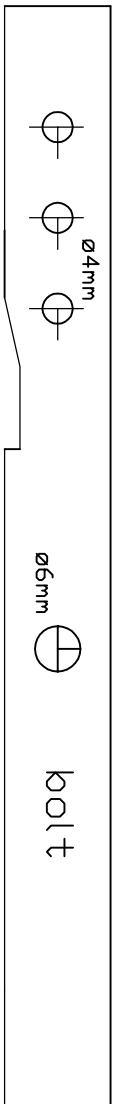

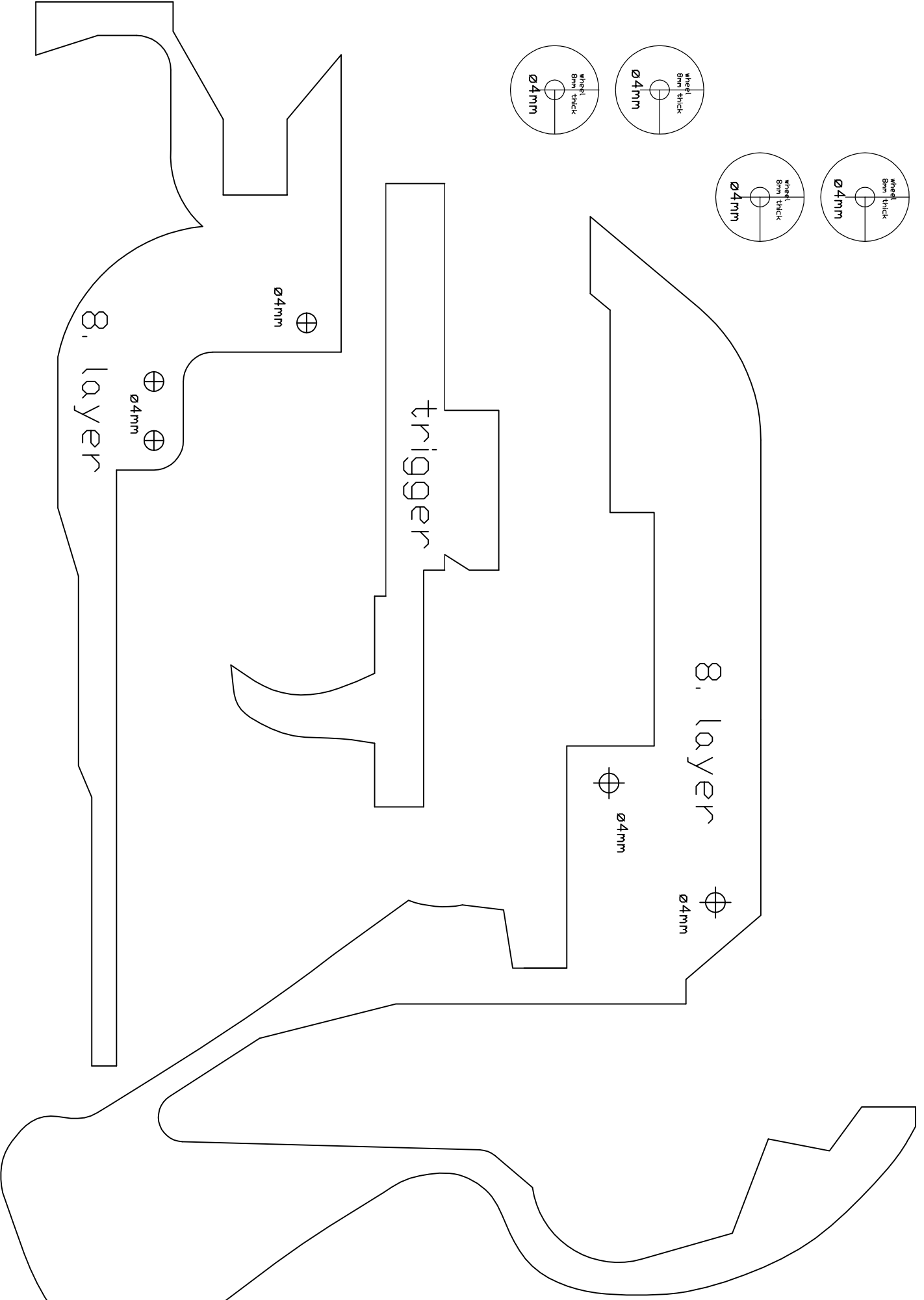
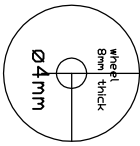
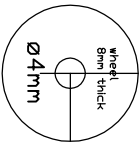
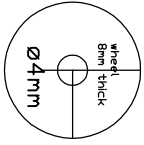
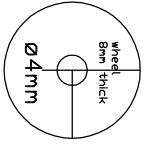

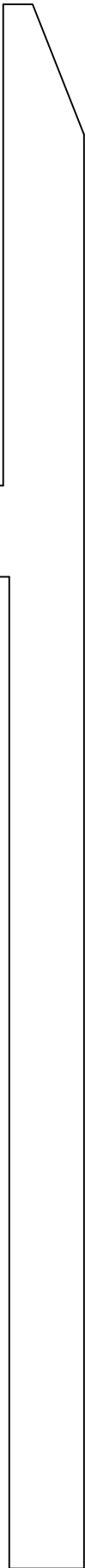

8. layer

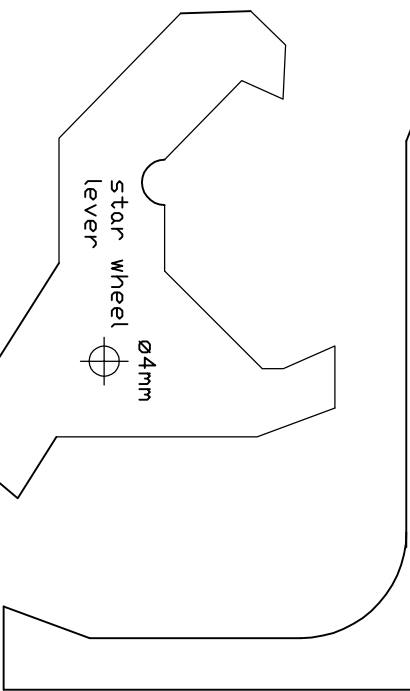

star wheel
lever

ø4mm

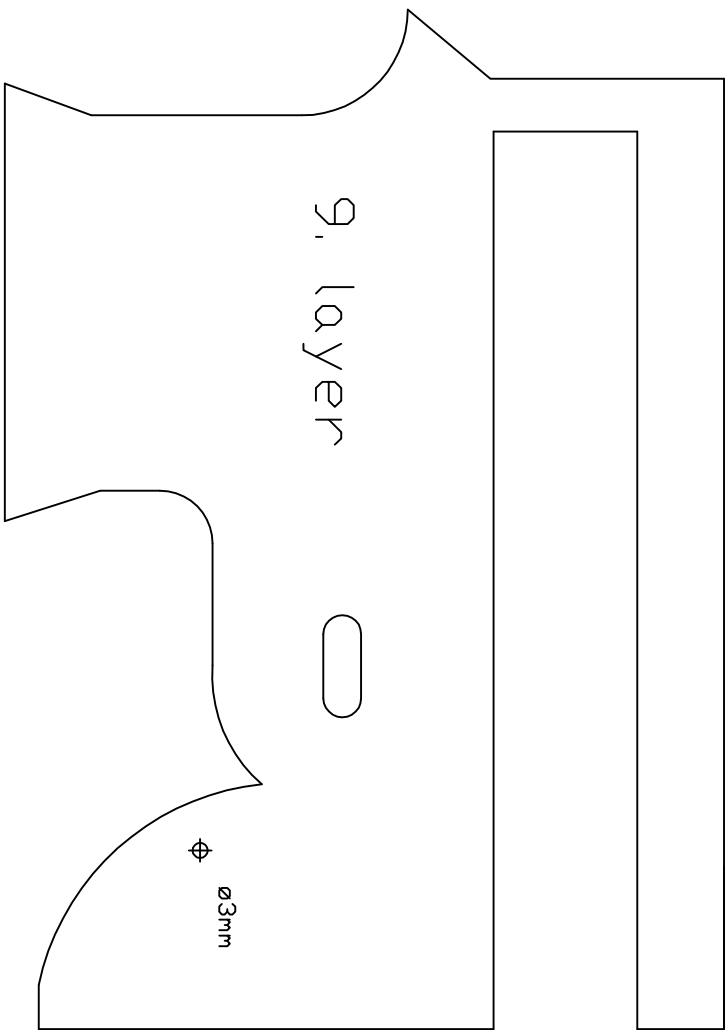

9. layer

ø3mm

star wheel
lever

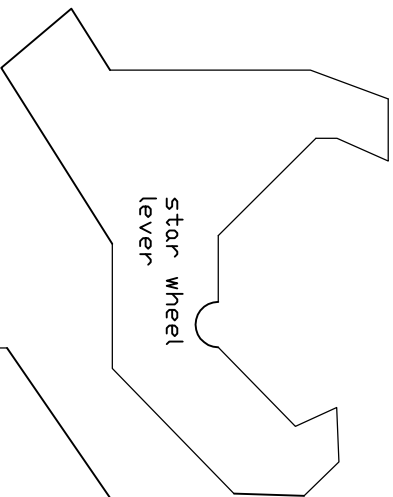

release
lever



release
lever

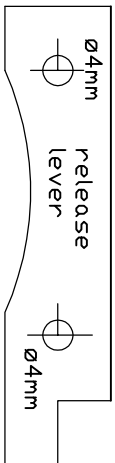
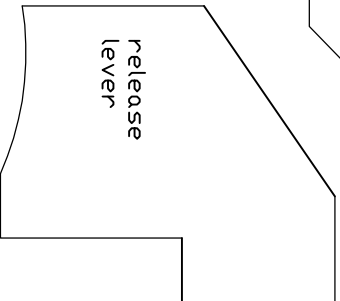

ø4mm

release
lever

ø4mm



wheel
thick
4mm
ø4mm
release
lever

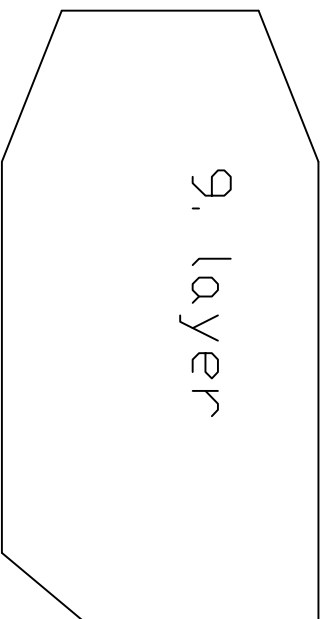

9. layer

Ø4mm



9. layer



Ø3mm

Ø3mm

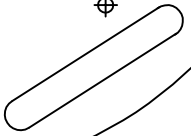

Ø3mm



10. layer

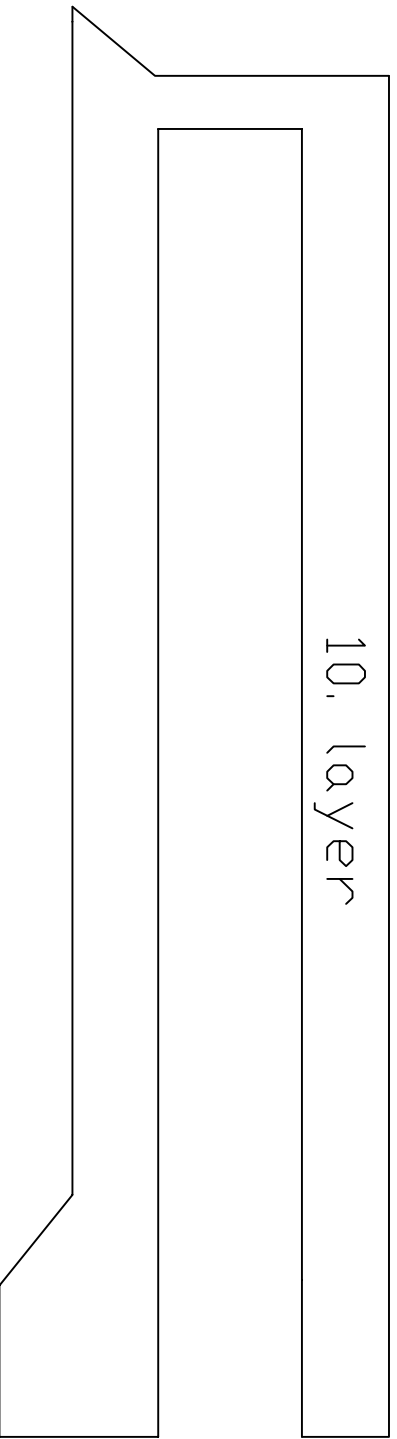

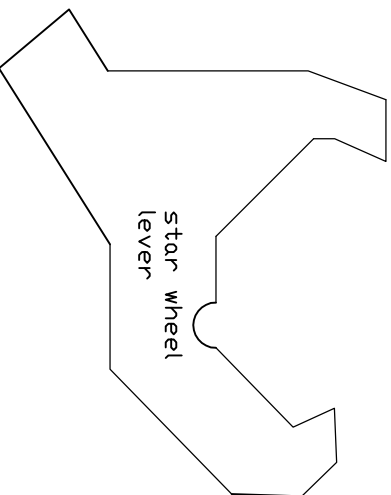
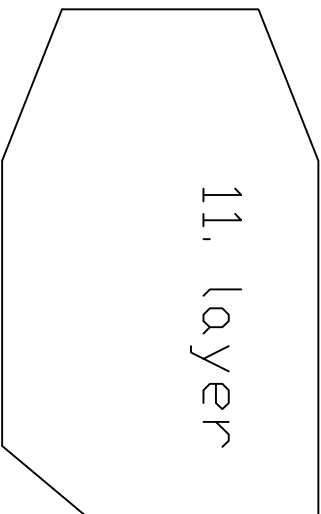
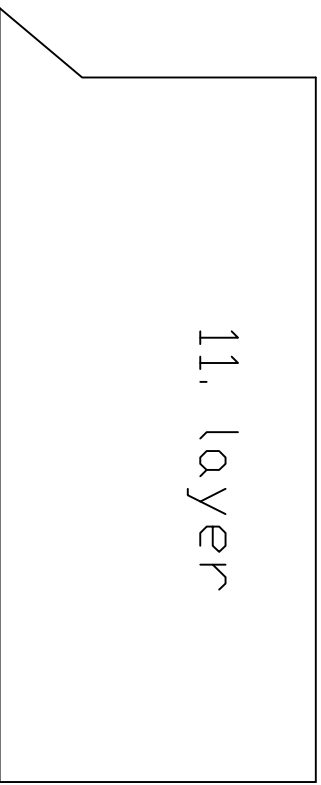
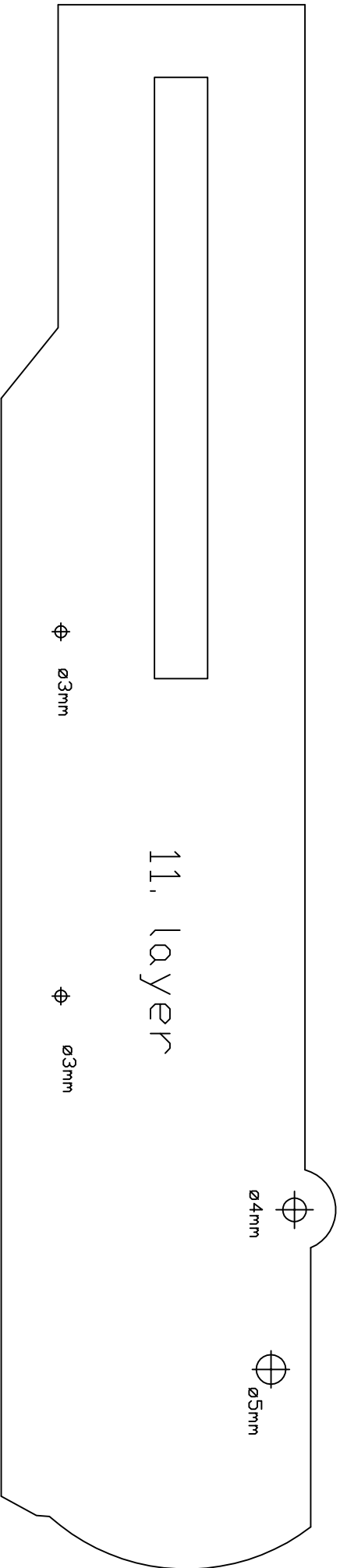
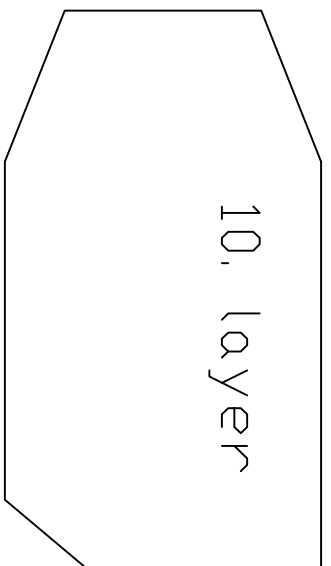
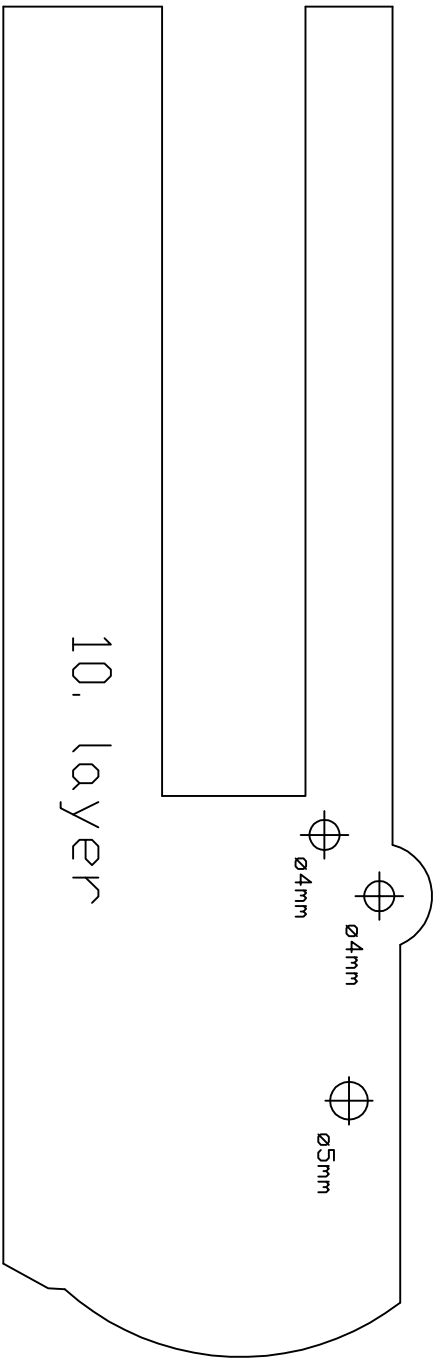

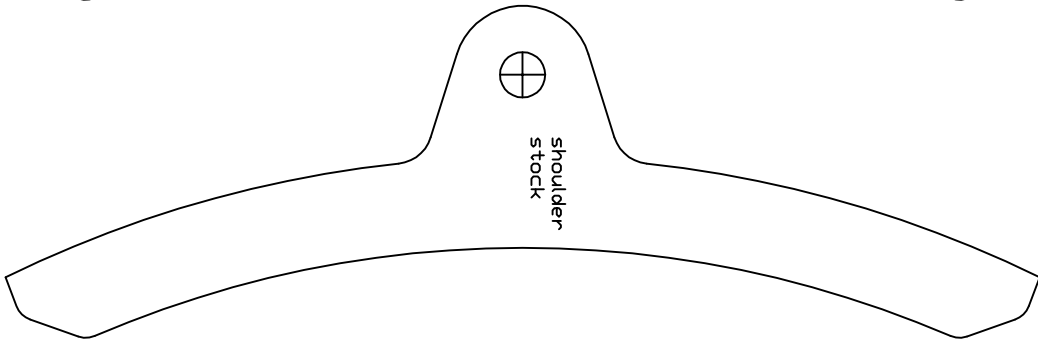
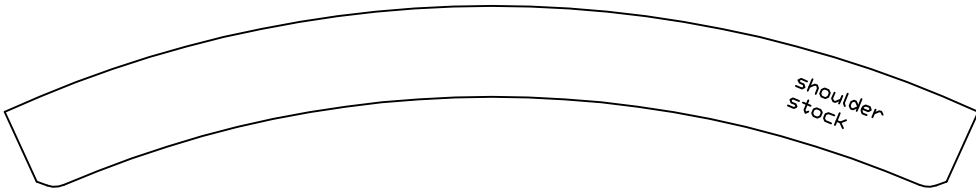
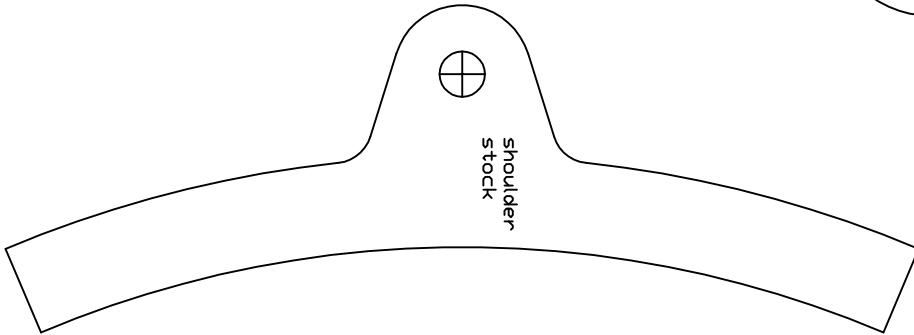
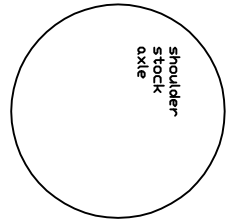
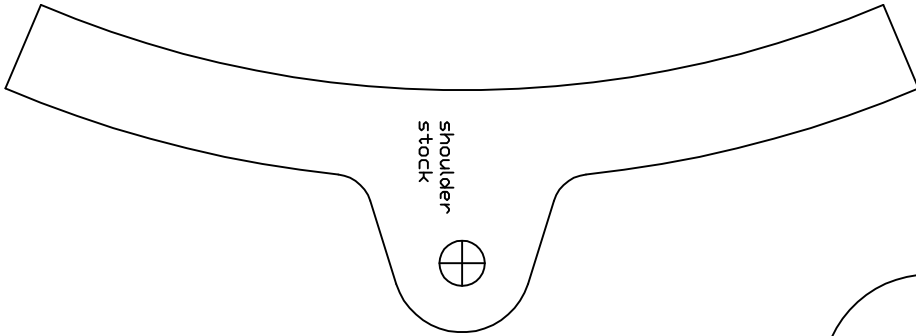
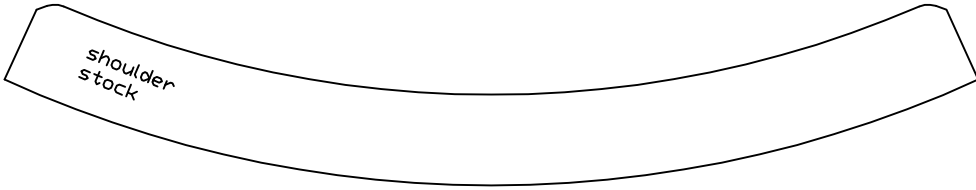
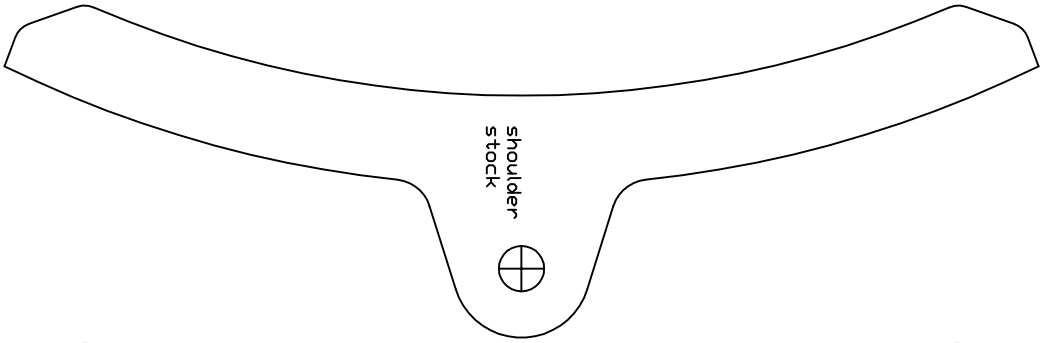

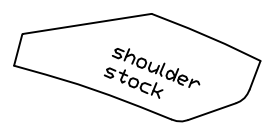
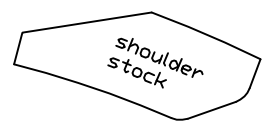
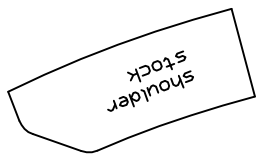
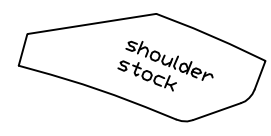
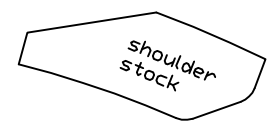
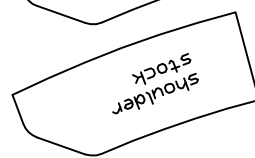
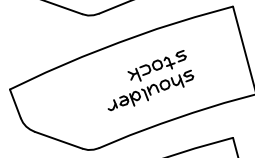
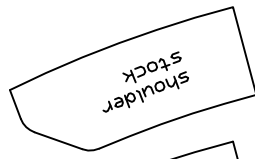
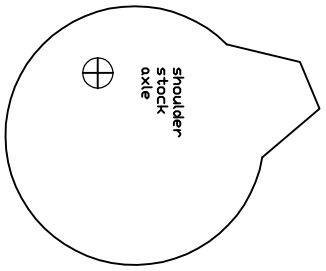
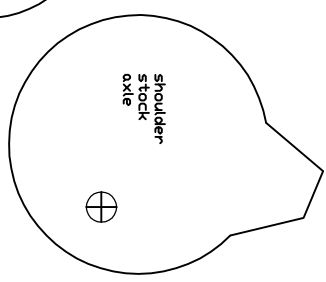
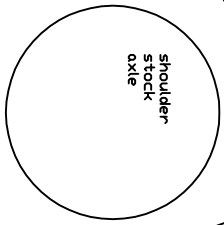
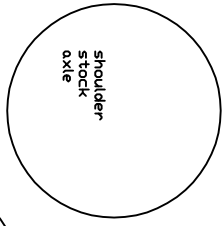
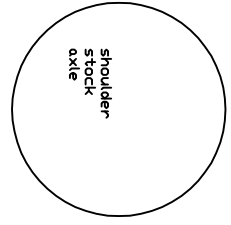
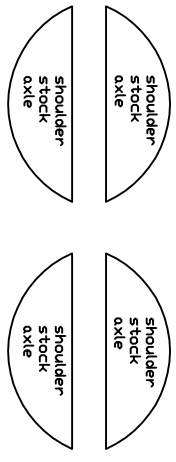
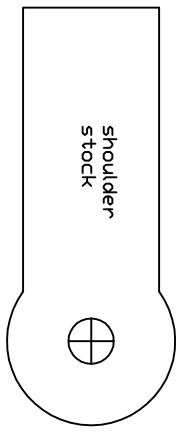
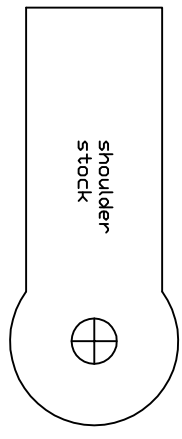
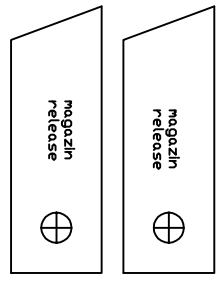
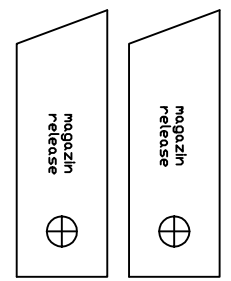
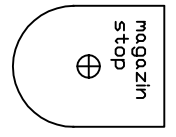

150

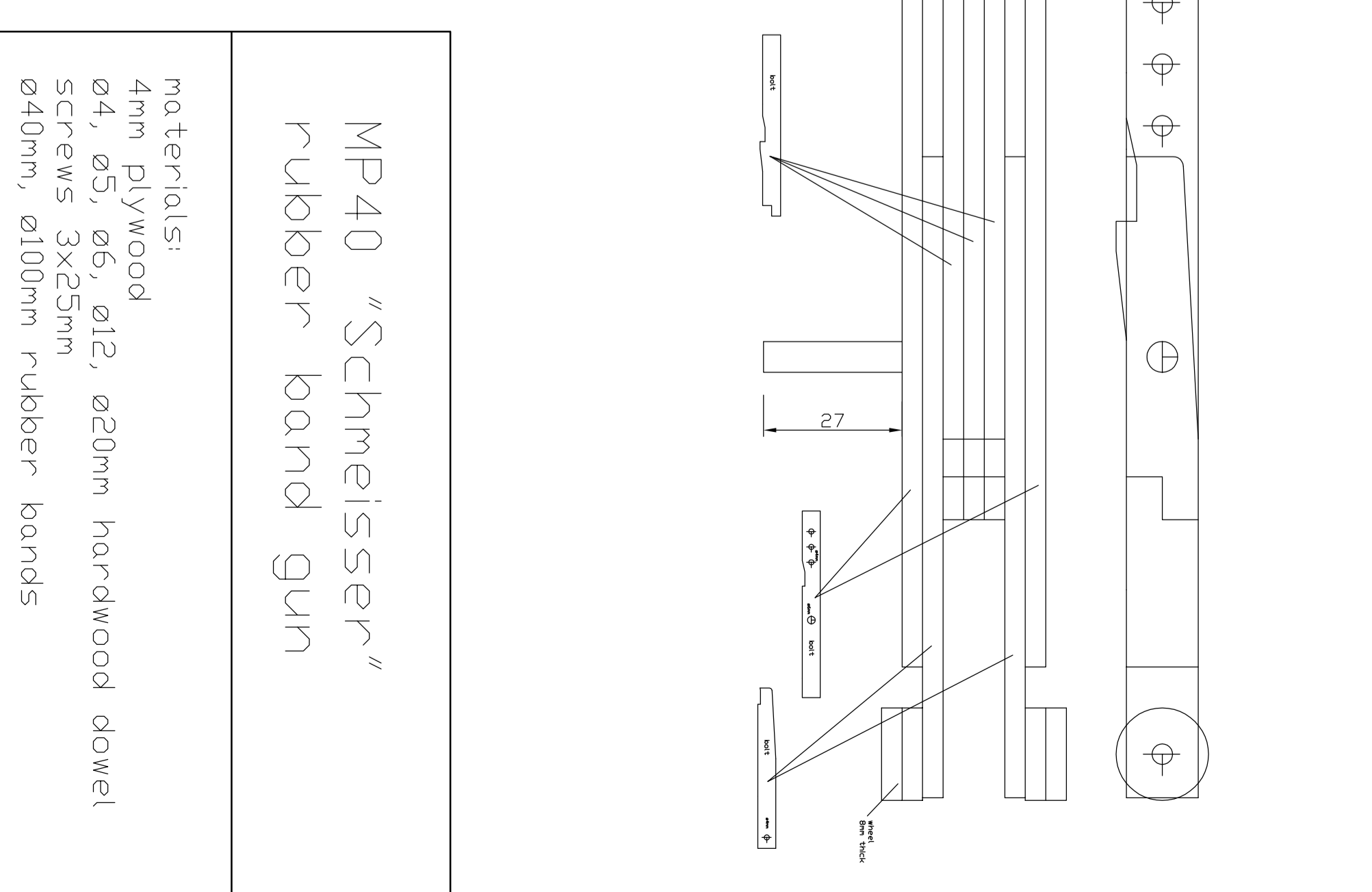
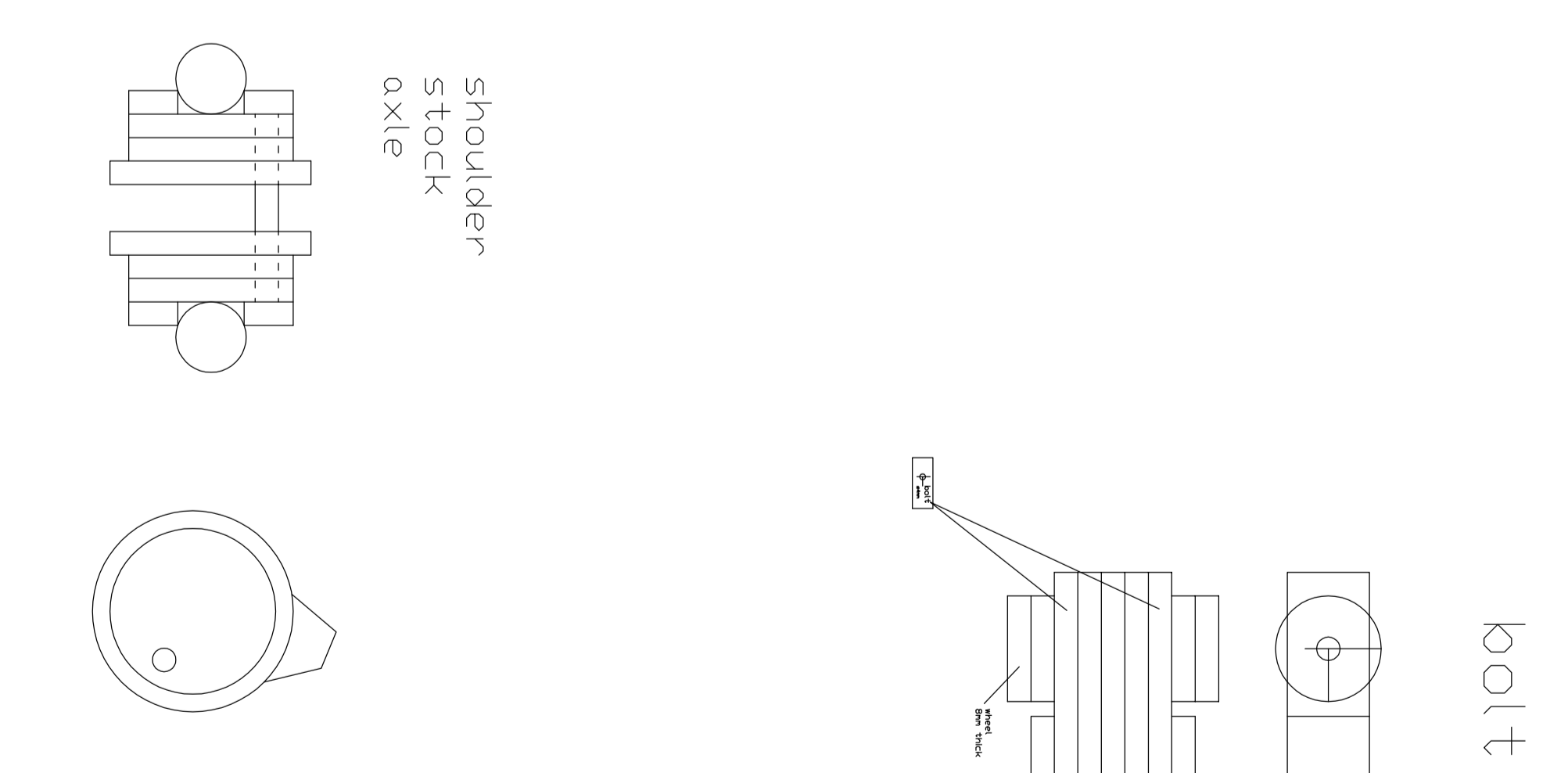
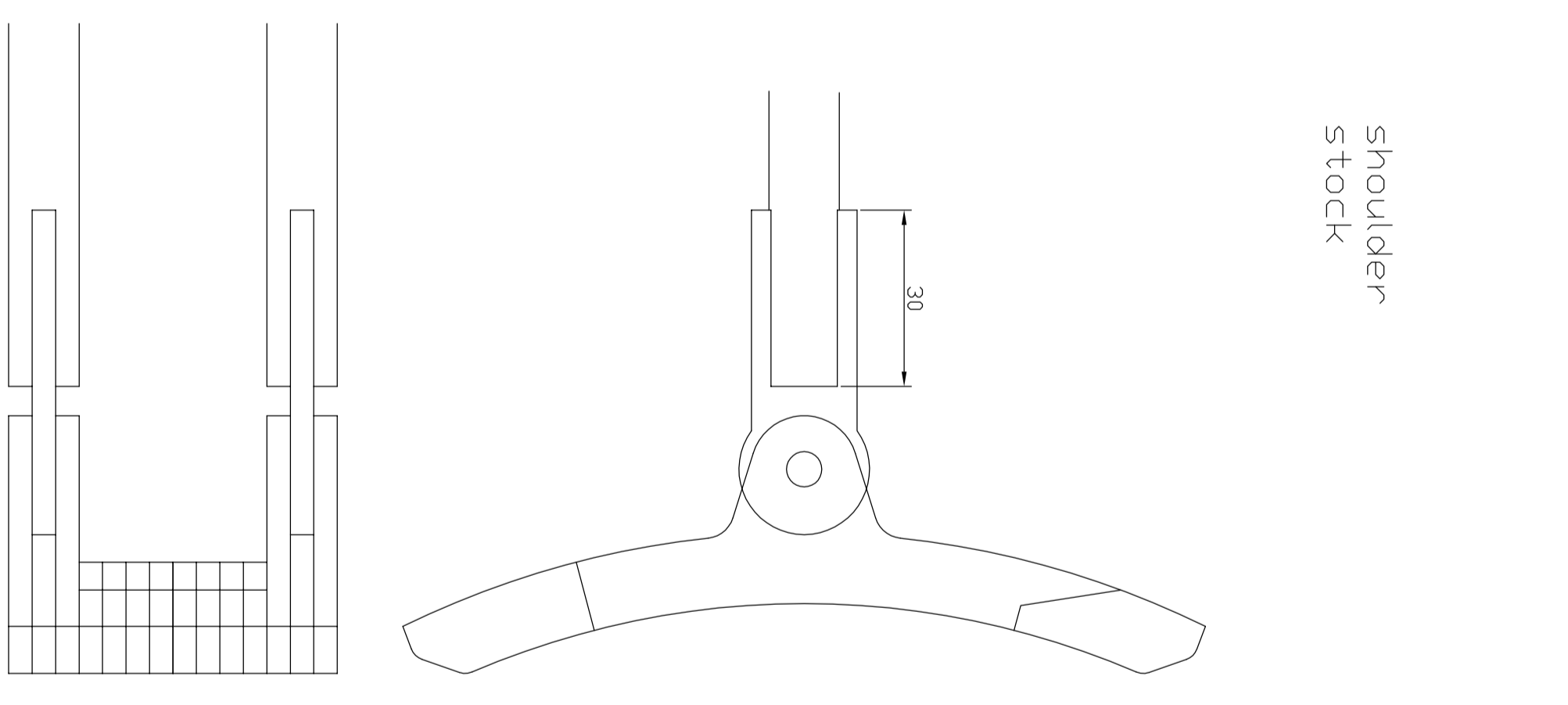
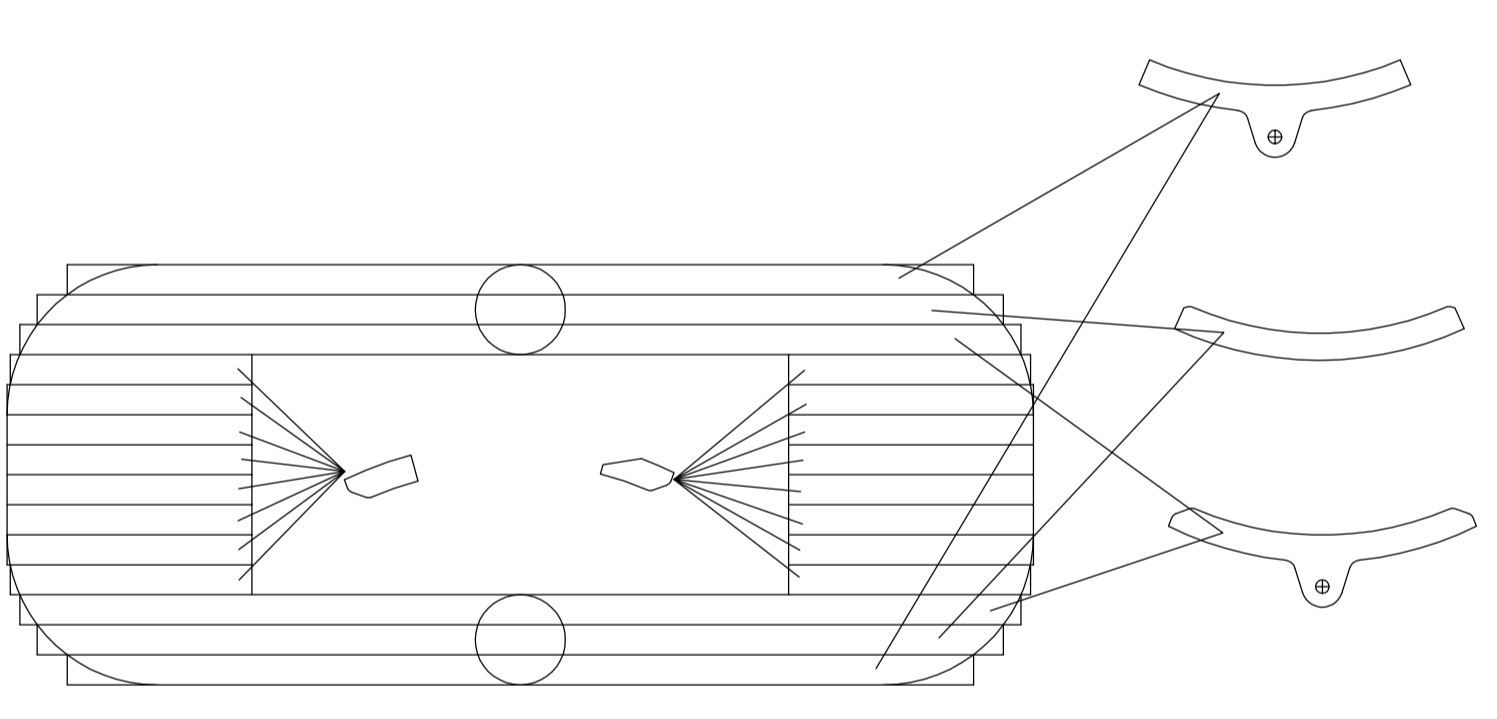
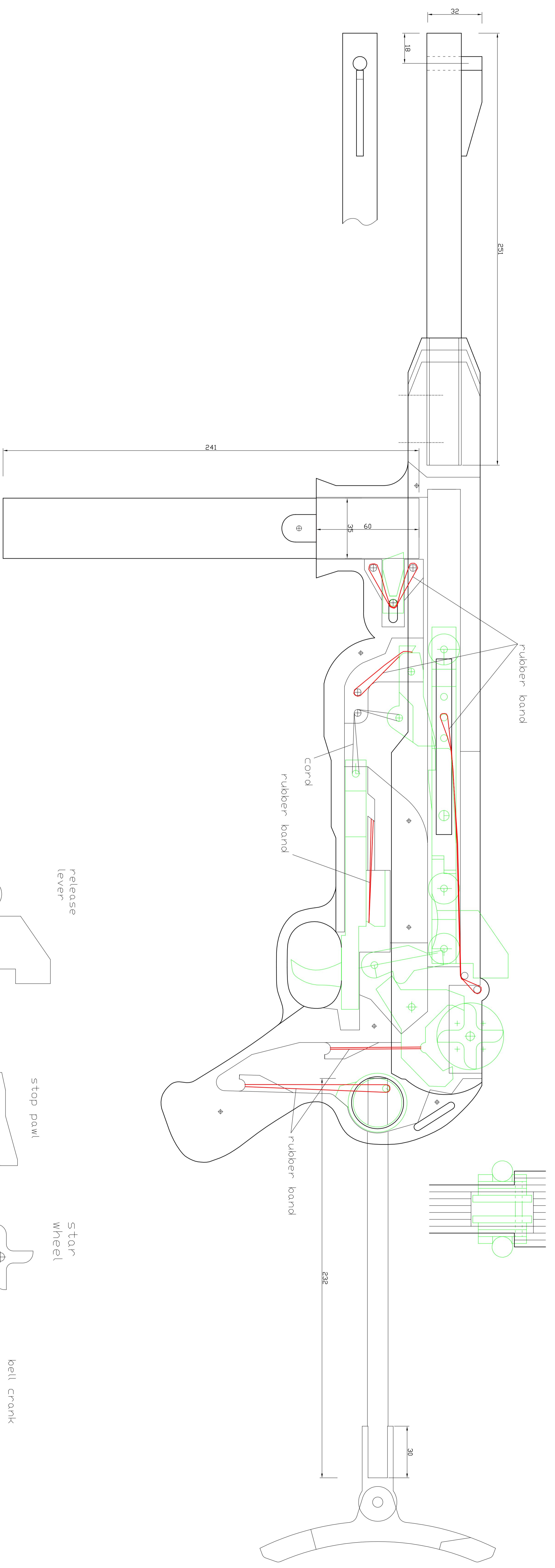
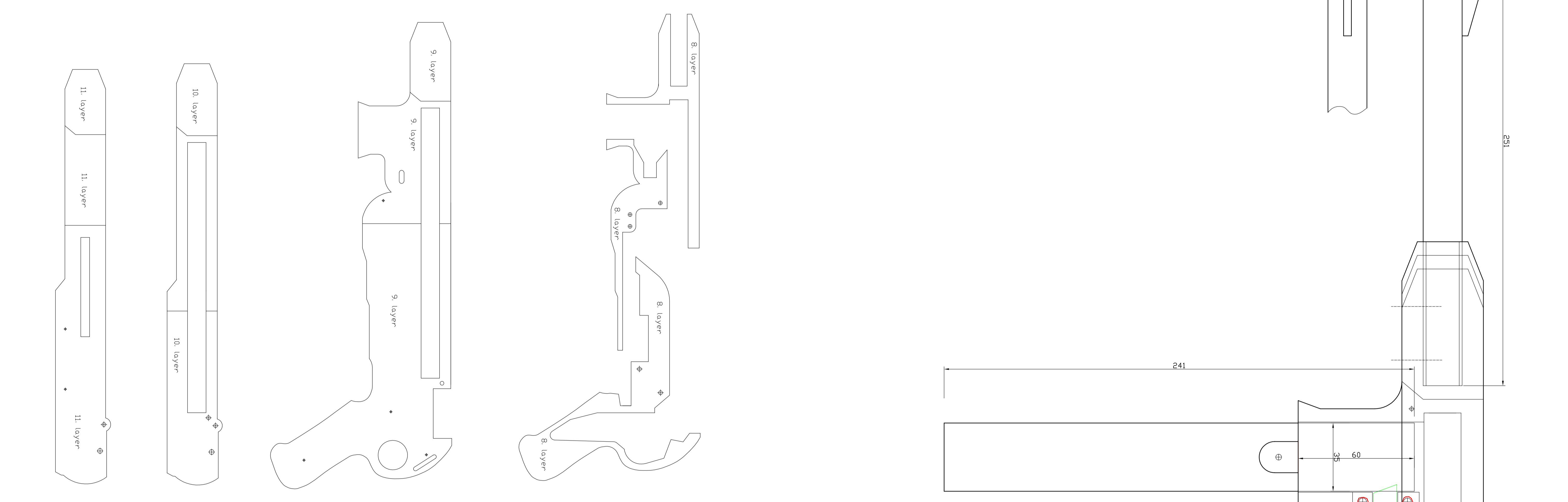
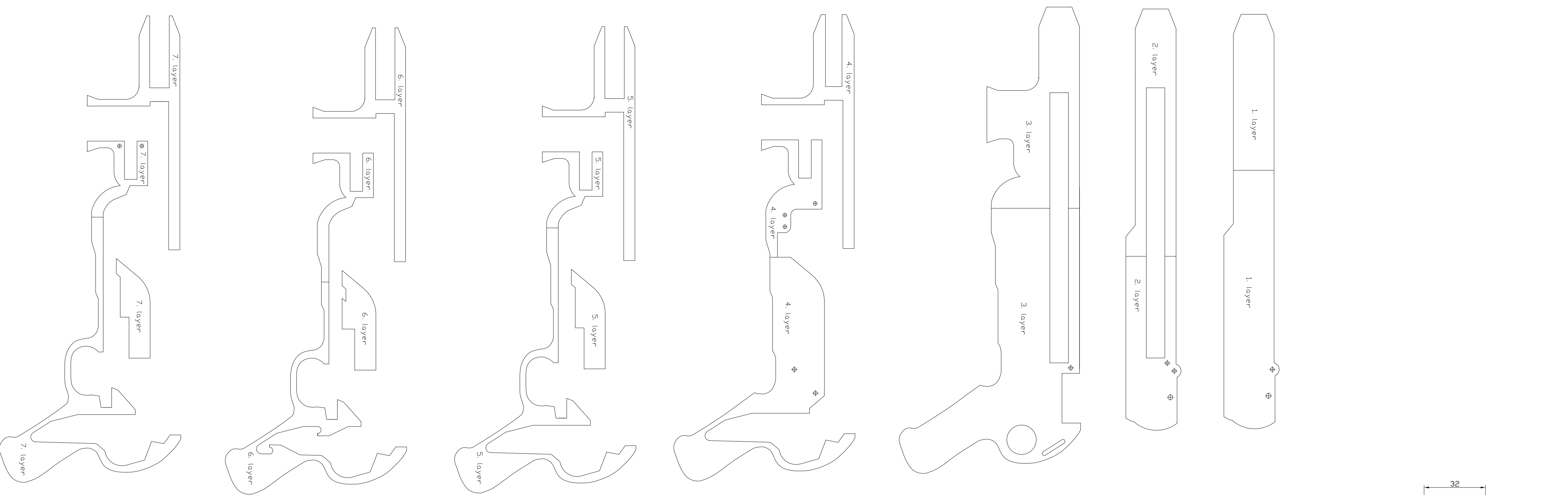

MP40 "Schmeisser"
rubber band gun

materials:
4mm plywood
ø4, ø5, ø6, ø12, ø20mm hardwood dowel
screws 3x25mm
ø40mm, ø100mm rubber bands

www.youtube.com/user/RBguns